

Panasonic®

HDTV DLP™ Projection Monitor Operating Instructions

Monitor de proyección de HDTV DLP™ Instrucciones de Operación

Téléprojecteur haute définition DLP™ Manuel d'utilisation

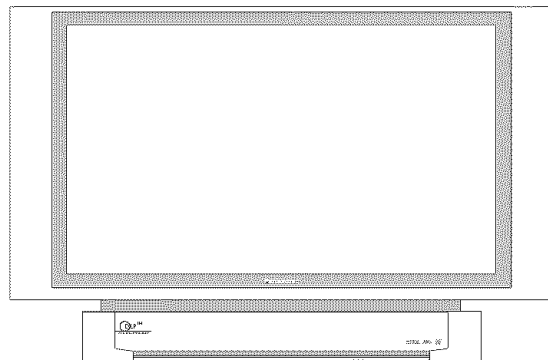

PT-60DL54
PT-50DL54
PT-50DL54X

TQB2AA0509 40514
PRINTED IN USA
IMPRESO EN EE.UU
IMPRIMÉ AUX ÉTATS-UNIS

	<p>WARNING RISK OF ELECTRIC SHOCK DO NOT OPEN</p>			<p>The lightning flash with arrow head within a triangle is intended to tell the user that parts inside the product constitute a risk of electric shock to persons.</p>
<p>WARNING: TO REDUCE THE RISK OF ELECTRIC SHOCK DO NOT REMOVE COVER OR BACK. NO USER-SERVICEABLE PARTS INSIDE. REFER SERVICING TO QUALIFIED SERVICE PERSONNEL.</p>				<p>The exclamation point within a triangle is intended to tell the user that important operating and servicing instructions are in the papers with the appliance.</p>
				<p>The pictorial representation of a hot surface within a triangle is intended to tell the user that parts inside the product are a risk of burns to persons.</p>

The Class II insulation symbol (square within a square) indicates that this product has been evaluated and tested to comply with Class II insulation requirements.

WARNING: TO REDUCE THE RISK OF FIRE OR ELECTRIC SHOCK, DO NOT EXPOSE THIS APPARATUS TO RAIN OR MOISTURE. DO NOT PLACE ANY OBJECTS FILLED WITH LIQUIDS, SUCH AS VASES, ON THIS APPARATUS.

IMPORTANT SAFETY INSTRUCTIONS

1. Read these instructions.
2. Keep these instructions.
3. Heed all warnings.
4. Follow all instructions.
5. Do not use this apparatus near water.
6. Clean only with dry cloth.
7. Do not block any ventilation openings. Install in accordance with the manufacturer's instructions.
8. Do not install near any heat sources such as radiators, heat registers, stoves, or other apparatus (including amplifiers) that produce heat.
9. Do not defeat the safety purpose of the polarized or grounding type plug. A polarized plug has two blades with one wider than the other. A grounding type plug has two blades and a third grounding prong. The wide blade or the third prong are provided for your safety. If the provided plug does not fit into your outlet, consult an electrician for replacement of the obsolete outlet.
10. Protect the power cord from being walked on or pinched particularly at plugs, convenience receptacles, and the point where they exit from the apparatus.
11. Only use attachments/accessories specified by the manufacturer.
12. Use only with the cart, stand, tripod, bracket or table specified by the manufacturer, or sold with the apparatus. When a cart is used, use caution when moving the cart/apparatus combination to avoid injury from tip-over.
13. Unplug this apparatus during lightning storms or when unused for long periods of time.
14. Refer all servicing to qualified service personnel. Servicing is required when the apparatus has been damaged in any way, such as power-supply cord or plug is damaged, liquid has been spilled or objects have fallen into the apparatus, the apparatus has been exposed to rain or moisture, does not operate normally, or has been dropped.



WARNING: Because the temperature of the lamp unit remains hot for a time after the TV is turned off, touching it may cause burns. Please allow the lamp to cool (for at least 1 hour) before handling or replacing the lamp unit.

CAUTION: Slots and openings in the cabinet and the back or bottom are provided for ventilation to ensure reliable operation of the projection TV and protect it from overheating. These openings must not be blocked or covered. There should be at least 4 inches between the cabinet and any wall.

Read these instructions completely before operating television.
Contents are subject to change without notice or obligation.

Copyright 2004 by Matsushita Electric Corporation of America. All rights reserved.
Unauthorized copying and distribution is a violation of law.

Important Information

FCC CAUTION: ANY CHANGES OR MODIFICATIONS TO THIS PTV RECEIVER NOT EXPRESSLY APPROVED BY MATSUSHITA ELECTRIC CORPORATION OF AMERICA COULD CAUSE HARMFUL INTERFERENCE, WHICH WOULD VOID THE USER'S AUTHORITY TO OPERATE THIS EQUIPMENT.

ENVIRONMENTAL NOTICE: FOR PRODUCT RECYCLING

THIS PRODUCT UTILIZES A HIGH PRESSURE MERCURY DISCHARGE LAMP THAT CONTAINS MERCURY AND OTHER COMPONENTS THAT CONTAIN LEAD. DISPOSAL OF THESE MATERIALS MAY BE REGULATED IN YOUR COMMUNITY DUE TO ENVIRONMENTAL CONSIDERATIONS. FOR DISPOSAL OR RECYCLING INFORMATION PLEASE CONTACT YOUR LOCAL AUTHORITIES, OR THE ELECTRONICS INDUSTRIES ALLIANCE: <HTTP://WWW.EIAE.ORG.>

FOR LAMP RECYCLING

Hg - LAMP CONTAINS MERCURY, MANAGE IN ACCORD WITH DISPOSAL LAWS. SEE: WWW.LAMPRECYCLE.ORG OR 1-888-843-9788

 <p>HDMI[™] HIGH DEFINITION MULTIMEDIA INTERFACE</p>	<p>HDMI, the HDMI logo and High Definition Multimedia Interface are trademarks or registered trademarks of HDMI Licensing LLC.</p>
---	--



The Energy Star label, a symbol for energy efficiency, was created by the U.S. Environmental Protection Agency (EPA) and the U.S. Department of Energy (DOE) to help customers identify products that can save them money and protect the environment by saving energy. Energy Star compliant products generally consume less energy than similar standard products.

	<p>SD Logo is a trademark.</p>
--	--------------------------------



Manufactured under license from BBE Sound, Inc.
Licensed by BBE Sound, Inc. under USP4638258, 5510752 and 5736897.
BBE and BBE symbol are registered trademarks of BBE Sound, Inc.

BBE ViVA HD3D (High Definition 3D) Sound provides musically accurate natural 3D image with Hi-Fi sound. The clarity of the sound is improved by BBE while the width, depth and height of sound image are expanded by BBE's proprietary 3D sound process. BBE ViVA HD3D Sound is compatible with all TV programs including news, music, dramas, movies, sports and electronic games.



BBE High Definition Sound restores clarity and presence for better speech intelligibility and music realism.

Trademarks

- DLP[™] is a registered trademark of Texas Instruments.
- VGA is a trademark of International Business Machines Corporation.
- Macintosh is a registered trademark of Apple Computer, USA.
- S-VGA is a registered trademark of the Video Electronics Standards Association.
- Even if no special notation has been made of company or product trademarks, these trademarks have been fully respected.

<p>For assistance, please call: 1-888-843-9788 or send e-mail to: consumerproducts@panasonic.com or visit us at www.panasonic.com</p>	<p>(U.S.A.)</p>
<p>For assistance, please call: 787-750-4300 or visit us at www.panasonic.com</p>	<p>(Puerto Rico)</p>
<p>For assistance, please call: 905-624-5505 or visit us at www.panasonic.ca</p>	<p>(Canada)</p>

ENGLISH

FCC Declaration of Conformity

Responsible Party:
Matsushita Electric Corporation of America
One Panasonic Way, Secaucus, NJ 07094
Contact Source:
Panasonic Consumer Electronics Company
1-800-211-PANA (7262)
E-mail: <http://www.panasonic.com/contactinfo>

FCC Information

This equipment has been tested and found to comply with the limit for a Class B Digital Device in accordance with the specifications in Part 15 of the FCC Rules. The limits are designed to provide reasonable protection against radio and television interference in a residential installation. This equipment generates, uses and can radiate radio frequency energy and, if not installed and used in accordance with the instructions, may cause harmful interference to radio communications. However, there is no guarantee that interference will not occur in a particular installation.

If this equipment does cause interference to radio or television reception (which you can determine by turning the equipment off and on), try to correct the interference by one or more of the following measures.

- Reorient or relocate the receiving antenna.
- Increase the separation between the equipment and the receiver.
- Connect the equipment into an outlet on a circuit different from that which the receiver is connected.
- Consult the dealer or an experienced radio/TV technician for help.

Industry Canada Information

This Class B digital apparatus complies with Canadian ICES-003.

Important Information when using the Projection TV

Reflection of external light

The DLP™ Projection Television should be installed so that external light shining on the screen is minimized. If sunlight or any bright light shines directly onto the screen, some part of the screen may appear white, whether the Projection Television is on or off. This is not a defect.

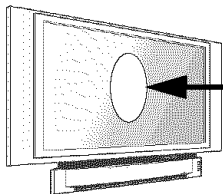

Screen may appear white from reflection of external light.

Cooling Fan Information

This Projection Television has a fan for cooling the built-in lamp. After turning the set off, the fan will continue cooling the lamp for about one minute.

Note: During the lamp cooling process you may hear sounds from the fan. This is not a defect, the sound will stop after one minute.

If the set is turned back on before the fan stops or the lamp is not cool enough, it may take a while to display a normal picture. This is not a defect.

Table of Contents

Important Information	1	Amplifier Connection	11
FCC Declaration of Conformity	2	Digital TV - Set-Top Box (DTV-STB) or DVD Players	11
FCC Information	2	Program Out Connection.....	11
Reflection of External Light.....	2	HDMI (High Definition Multimedia Interface) Input Connection	12
Cooling Fan Information	2	Special Features	13
Customer Record.....	4	ASPECT Button.....	13
Care and Cleaning.....	4	BBE Button.....	13
Specifications.....	4	SAP Button.....	13
Feature Chart.....	4	Split Screen Operation	13
Installation.....	5	Split Screen Operation with Cable Box	13
Television Location	5	Split Screen Operational Buttons	14
Optional Cable Connections	5	Split CTRL Button	14
AC Power Supply Cord.....	5	TV/Video Button.....	14
Cable / Antenna Connection.....	5	Search Button	14
Safety Precautions.....	5	Freeze Button	14
Affixing Projection Television to a Wall	5	Main Picture Freeze Feature	14
Viewing Position	5	Direct Video Input Selection	14
Remote Control Battery Installation	6	Remote Control Operation	15
Replacing the lamp unit	6	Programming the Remote	16
Lamp Unit Replacement Period.....	6	Programming Without a Code	16
Important Points to Keep in Mind.....	6	Component Codes	16
Cautions for Lamp Unit Replacement.....	6	Operating Components with Remote Control.....	19
Procedures to Turn Power Off	6	Basic Menu Navigation.....	21
Power On/Off.....	7	Icon Menus Operation	22
Connecting the Plug to the Wall	7	Picture	22
Turning the Power On and Off.....	7	Audio	22
Power Indicator Chart.....	7	Channels	23
Initial Set Up Menu.....	7	Timer	24
Front , Rear and Right Side View of the Projection Television.....	8	Lock.....	24
Optional Equipment Connections.....	9	Set Up	27
RGB Input Connection.....	9	Photo Viewer Operation	29
Analog RGB Signals that can be Input	9	Troubleshooting Chart	31
VCR	10	Index.....	33
Cable Box	10		
VCR and Cable Box.....	10		

Note: The warranty and service center information is located in the back of this manual.

Congratulations

Your new Projection Television features state-of-the-art technology for high quality picture and sound with complete audio/video connections for your home theater system. Your Projection Television is designed to give you many years of enjoyment. It was thoroughly tested and tuned at the factory for best performance.

Customer Record

The model and serial number of this product are located on the back of the Projection Television. You should note the model and serial number in the space provided and retain as a permanent record of your purchase. This will aid in identification in the event of theft or loss. Product registration for U.S. customers is available at: www.prodreg.com/panasonic.

Model
 Number
 Serial
 Number

Care and Cleaning

Screen (Turn Projection Television Off)

To ensure continued excellent performance by this product, periodic cleaning is recommended.

- Dust will accumulate on the picture screen. Please wipe with a soft cloth from time to time.

Warning: Do not spray any type of cleaning fluid directly on the screen.

Cabinet and Remote Control

- For cabinets and remote control, use a soft cloth dampened with water or a mild detergent solution. Avoid excessive moisture and wipe dry.
- Do not use benzene, thinner or other petroleum based products.
- For cabinets, do not bring into contact with insecticide or other volatile substances.
- Do not allow the unit to come into contact for extended periods with rubber or vinyl products.

Specifications

Specifications are subject to change without notice or obligation.

Power Source	
PT-60DL54 (2.4A)	120 V AC, 60Hz
PT-50DL54 (2.4A)	120 V AC, 60Hz
PT-50DL54X (2.4A)	127 V AC, 60Hz
Channel Capability - 181	VHF-12; UHF-56; Cable-113
Video Input Jacks	1Vp-p, 75 Ohm, Phono Jack Type
Audio Input Jacks	500mV RMS 47K Ohm
Video out jack	1Vp-p, 75 Ohm, Phono Jack Type
Audio Output Jacks	0-2.0V RMS 4.7K Ohm
HDMI Input jack	Type A
RGB Inputs	D-Sub 15pin
Components Input (Y / P_B / P_R)	75 Ohm, Phono Jack Type
S-Video Input Jacks	S-Video (Y-C) Connector
Projection Lamp	100 W HiD (High Intensity Discharge) Lamp (recommended replacement period approximately 10,000 hours)

Feature Chart

MODELS	PT-50DL54	PT-50DL54X	PT-60DL54
FEATURES			
MENU LANGUAGE ENG/SPAN/FR	•	•	•
2 TUNER SPLIT SCREEN	•	•	•
CLOSED CAPTIONING	•	•	•
V-CHIP CAPABILITY	•	•	•
DIGITAL SCAN RATE	720p	720p	720p
NTSC LINE-DOUBLER	480p	480p	480p
RESOLUTION	1280 X 720	1280 X 720	1280 X 720
RGB RESOLUTION	VGA (640 X 480) SVGA (800 X 600) XGA (1024 X 768)	VGA (640 X 480) SVGA (800 X 600) XGA (1024 X 768)	VGA (640 X 480) SVGA (800 X 600) XGA (1024 X 768)
VIDEO NORM	•	•	•
AUDIO NORM	•	•	•
STEREO	•	•	•
AI SOUND	•	•	•
BASS/TREBLE/BALANCE/	•	•	•
SURROUND SOUND	•	•	•
BBE/VIVA SOUND	•	•	•
A/V IN (REAR/SIDE)	3 (2/1)	3 (2/1)	3 (2/1)
AUDIO OUT	•	•	•
RGB INPUT	2	2	2
HDMI/HDCP INPUT	•	•	•
S-VHS INPUT (REAR/SIDE)	3 (2/1)	3 (2/1)	3 (2/1)
COMPONENT INPUT	3	3	3

Installation

Television Location

This unit can be used as part of an entertainment center. Consult your dealer for available options.

- Avoid excessive sunlight or bright lights, including reflections.
- Keep away from excessive heat or moisture. Inadequate ventilation may cause internal component failure.
- Fluorescent lighting may reduce remote control transmitting range.
- Keep away from magnetic equipment, including motors, fans and external speakers.

WARNING: Use this Projection Television receiver only with the cart, stand, tripod, bracket, or table specified by the manufacturer, or sold with the apparatus. When a cart is used, use caution when moving the cart/apparatus combination to avoid injury from tip-over. In order to avoid injury to children, never place your Projection Television receiver on a piece of furniture that is capable of being tilted by a child leaning on it, pulling on it, standing on it, or climbing on it. A falling Projection Television can cause serious injury or even death.



PT-50DL54:

CAUTION: This Projection receiver for use only with PANASONIC TY-50DL54K stand. Use with other carts (or stands) is capable of resulting in instability causing possible injury.

PT-50DL54X:

CAUTION: This Projection receiver for use only with PANASONIC TY-50DL54K stand. Use with other carts (or stands) is capable of resulting in instability causing possible injury.

PT-60DL54:

CAUTION: This Projection receiver for use only with PANASONIC TY-60DL54K stand. Use with other carts (or stands) is capable of resulting in instability causing possible injury.

Optional Cable Connections

Shielded audio and video cables should be used between components. For best results:

- Use 75-ohm coaxial shielded cables.
- Use appropriate input and output connectors that match your component connectors.
- Avoid long cables to minimize interference.

AC Power Supply Cord

CAUTION: TO PREVENT ELECTRIC SHOCK, MATCH WIDE BLADE OF PLUG TO WIDE SLOT OF AC OUTLET AND FULLY INSERT. DO NOT USE A PLUG WITH A RECEPTACLE OR OTHER OUTLET UNLESS THE BLADE CAN BE FULLY INSERTED TO PREVENT BLADE EXPOSURE.

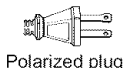

Polarized plug

PROTECT POWER CORDS FROM BEING WALKED ON, ROLLED OVER, CRIMPED, BENT, OR PINCHED, PARTICULARLY AT PLUGS, CONVENIENCE RECEPTACLES, AND THE POINT WHERE THEY EXIT FROM THE APPARATUS.

Cable / Antenna Connection

For proper reception, either a cable or antenna connection is required.

Cable Connection

Connect the cable supplied by your local cable company. Tighten with fingers only. Use of any tool (e.g. pliers) for tightening may result in tuner damage.

Note: A cable converter box may be required for proper reception. Check with your local cable company for compatibility requirements.

Incoming Cable from Cable Company

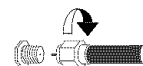

75 Ohm VHF/UHF on back of PTV

Antenna Connection

For proper reception of VHF/UHF channels, an external antenna is required. For best reception an outdoor antenna is recommended.

- Connect home antenna to ANT connection on back of television.

Note: Cable Mode is preset at the factory.

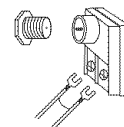

Incoming Cable from Home Antenna

Safety Precautions

Please take safety precautions to prevent the unit from falling over. The unit may fall over during earthquakes, or if someone stands on or shakes the projection TV.

Procedure

- Use a strong rope or a chain (not included) to fasten the projection TV firmly to a strong support such as a wall or pillar.

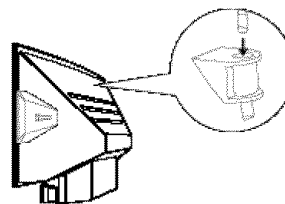

Viewing Position

To optimize your viewing comfort, please follow the viewing guidelines shown in the diagrams below. If viewing for an extended period of time, sit as far back from the screen as possible.

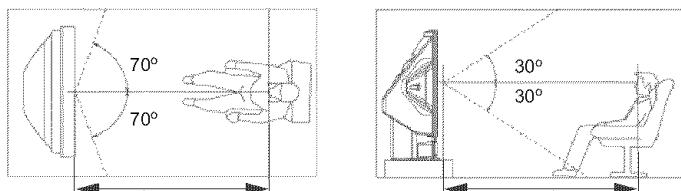

Viewing distance for 50" models is at least 6 feet and for 60" is at least 7 feet.

Note: If you view the Projection Television at a short distance for a long time, your eyes may become fatigued.

INSTALLATION

Remote Control Battery Installation

Requires two AA batteries (supplied).

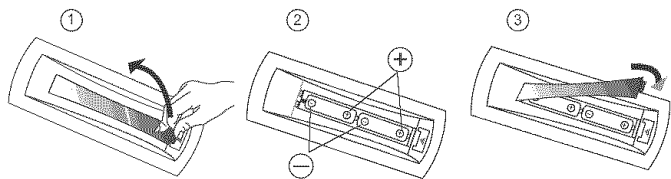

Procedure

1. Remove battery cover by pushing in on the catch while lifting the cover up.
2. Install batteries by matching (+) and (-) polarity signs in the compartment.
3. Re-insert the cover and press down the cover until it snaps shut.

Note: Incorrect installation can cause battery leakage and corrosion that will damage the Remote Control.

Precautions

- Replace batteries in pairs.
- Do not mix battery types (zinc carbon with alkaline).
- Do not recharge, heat, short-circuit, disassemble, or burn batteries.

Replacing the lamp unit (For USA and Canada only)

(USA only)

The lamp unit is sold separately **Lamp unit Part No. : TY-LA2004**. To purchase a replacement, call the Panasonic accessory department, toll free at: **1-800-332-5368**.

(Canada only)

For product operation and information assistance, please contact your Dealer or our Customer Care Centre at: **(905) 624-5505**.

Lamp unit replacement period

The lamp unit for the projection TV should be replaced after approximately 10,000 hours of use in the normal usage mode. Due to the characteristics and use conditions of individual lamps, the lamp may cease to light before the stated lamp life. Influences of frequent lighting, continuous light use for over 24 hours, the number of times lit, the length of time between lightings, etc. may shorten lamp life. Because of this, having a replacement lamp on hand is recommended.

A warning will display after 10,000 hours of use. When the power is turned on after 10,000 hours of continued use, **REPLACE LAMP** will be displayed for approximately 1 min. A warning message to urge the replacement of the lamp will be displayed in red at the center of the screen.

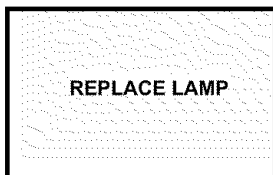

Important Points to keep in mind

When replacing the lamp unit, pay attention to the following points.

Warning:

- The lamp unit is hot during operation and touching it immediately after use may cause burns.
- Please allow the lamp to cool (**for at least 1 hour**) before handling or replacing the lamp unit.

Cautions for Lamp Unit Replacement:

- Handle the old lamp unit carefully. If mishandled, it may explode.
- Wear gloves when replacing the lamp unit.
- If replacing the lamp unit becomes necessary during the operation of the TV, follow the procedure below to turn off the power and wait until the lamp unit cools completely.

Procedures to turn Power Off

1. Press the **POWER** button to turn off the power.
2. Wait for about one minute until the cooling fan stops.

Note: The lamp cooling fan will continue to operate for about one minute after turning off the power. Do not unplug the power cord from the outlet until the fan has stopped. Avoid interrupting the power line such as by using circuit breakers or switchable power strips.

3. Unplug the power cord from the outlet.

For USA and Canada only.

Refer to the instructions enclosed with the lamp unit (Part No. TY-LA2004) when replacing the lamp.

POWER ON/OFF

Connecting the Plug to the Wall Outlet

The projection TV must first be plugged into an AC outlet. The projection TV will then be in standby mode.

Turning the Power ON and OFF

Always be sure to follow the procedure below to turn the Projection Television power ON and OFF.

The lamp cooling fan will continue to operate for approximately one minute after the power is turned off by the remote control.

After the cooling fan has stopped, the power indicator will not illuminate (Stand-by mode). If you wish to turn the power ON while the cooling fan is operating, press the power button. The power indicator on the Projection Television will then flash in green, and the projection Projection Television will turn ON as soon as the cooling fan stops. Always use the remote control or power button on the Projection Television to turn the power OFF.

Caution: Do not turn off by external power strip or by pulling plug. Do not open any circuit breakers while the cooling fan is still operating.

Procedure for turning ON

- Press the Power button to turn the projection TV on, from Stand-by mode.

Note: The Power Indicator will blink green for approximately 10 seconds, and then become green.

Procedure for turning OFF

- Press the Power button to turn the projection TV to Stand-by mode.

Notes:

- The Power Indicator will become orange for approximately 10 seconds.
- The Power Indicator will blink orange for approximately 60 seconds.
- The Power Indicator light will go out.

Note: The Projection Television will consume a small amount of power as long as the power cord is connected to a power outlet.

Power Indicator Chart

LED	ACTION
Not illuminated	Stand-by
Green	Power – ON
Green blink	Power – ON (approximately 10 seconds after)
Orange	Power – OFF (Blinking mode) (approximately 10 seconds after)
Orange blink	Power – OFF (Cooling mode) (approximately 40 seconds after)

Initial Set Up Menu

For your convenience, the Initial Set Up menu will be displayed on screen when the set is turned on for the first time. If needed, follow the menus and procedures for setting up the features.

IDIOMA/LANGUE

To change menu language to ENGLISH, SPANISH or FRENCH.

Procedure

- Press **VOL** ► to select English, Spanish or French.

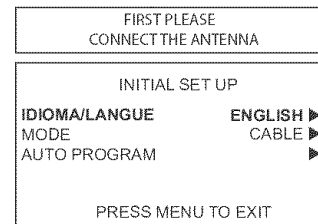

MODE

To select TV (antenna) or CABLE mode depending on the signal source.

Procedure

- Press **VOL** ► to select TV or CABLE.

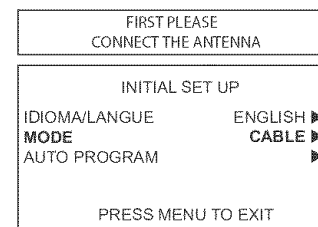

AUTO PROGRAM

To automatically program all channels received through the RF input.

Procedure

- Press **VOL** ► to start Auto Programming.

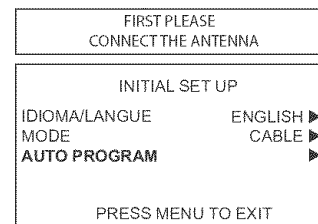

Front, Rear and Right side View of the Projection Television

Front Panel

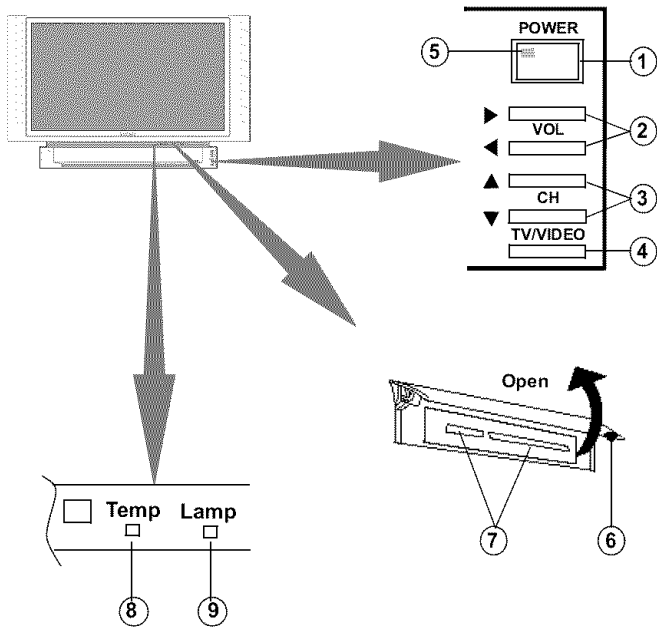

Item #	Description
①	Input 3 A/V inputs for connecting VCR, Palmcorders or other devices. Note: Press TV/Video button to select Video 3.
②	Audio In and RGB 2 In For connecting a PC with RGB output.

Rear Panel Jacks

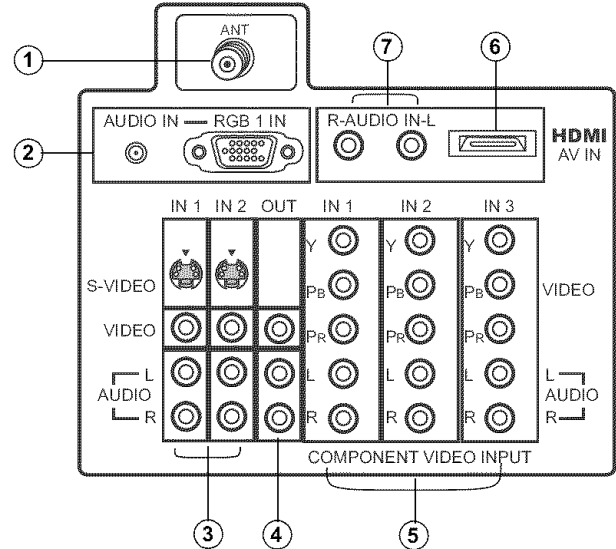

Item #	Description
①	Antenna Inputs ANT - Connect cable antenna or terrestrial antenna to this input.
②	Audio In and RGB 1 In For connecting a PC with RGB output.
③	INPUTS 1 and 2 A/V inputs for connecting VCR and other devices.
④	Prog Out Terminals that output fixed and variable audio and NTSC composite video.
⑤	COMPONENT VIDEO (Y-P_B-P_R) INPUTS Use these jacks for connecting devices such as a DVD player or Set Top Box.
⑥	HDMI (High Definition Multimedia Interface) Input that accepts uncompressed digital signal and multi channel digital audio signal.
⑦	AUDIO IN R/L Use these audio inputs when DVI devices are connected to HDMI input using the DVI to HDMI adaptor.

Feature	Description
① POWER	Toggles power OFF/ON
② ◀VOL and VOL▶	Decrease or increase volume, navigate left/right in menu, adjust selected feature in menu.
③ ▼CH and CH▲	Tune to lower or higher channels, navigate up/down in menus.
④ TV/VIDEO	Change input source
⑤ ON/OFF Indicator	The ON/OFF indicator LED (green) will be lit when Projection Television is on.
⑥ DOOR	Pull up here to access SD and PC slots.
⑦ SD and PC Slots	Use to insert and remove cards for Photo Viewer feature.
⑧ Temp	This indicator lights up when there is an abnormal temperature in the unit.
⑨ Lamp	This indicator lights up when there is a malfunction with the lamp unit.

Right Side Panel

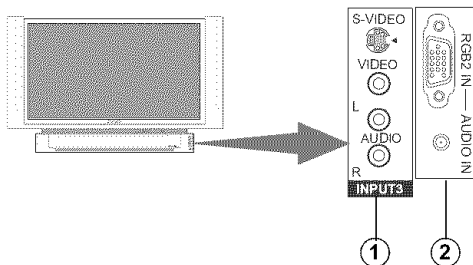

Optional Equipment Connections

RGB Input Connection

Procedure

- Press the TV/VIDEO button (refer to page 14) to select RGB 1 or RGB 2 input.
- Connect a RGB cable to Computer or Laptop RGB output.

Note: If no RGB signal is displayed after connecting laptop, please refer to laptop manual for procedure on how to switch the output signal.

- Connect the other end of the RGB cable to RGB IN 1 or side RGB IN 2 on Projection Television.
- Connect the audio cable to Computer or Laptop AUDIO OUT.
- Connect the other end of the audio cable to AUDIO IN on Projection Television.

Note: RGB 2 input is located on lower right side of cabinet.
Computer Laptop

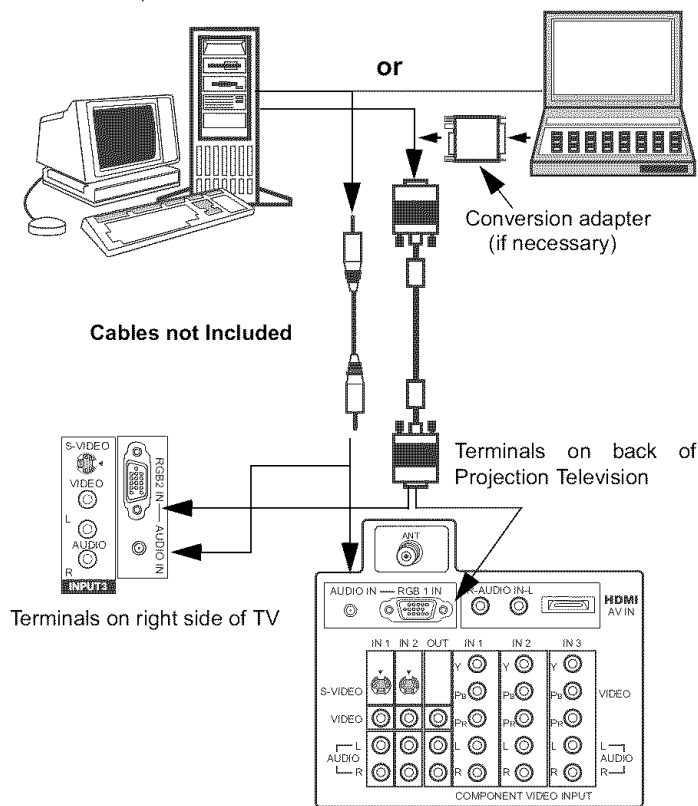

Notes:

- Some PC models cannot be connected to the Projection Television.
- The PC display size will be 4:2:2 format.
- There is no need to use an adapter for computers with PC / AT compatible D-SUB 15P terminal.
- The computer shown is for illustrative purposes only.
- Additional equipment and cables shown are not supplied with this Projection Television.
- The picture will become dark if a RGB signal with a vertical scanning frequency of 62 Hz is input. To obtain the optimum picture quality with the Projection Television, a vertical scanning frequency of 60 Hz is recommended.

Analog RGB signals that can be input

The table below lists the different types of analog RGB signals that can be input. If a signal which differs greatly from any of the types listed below is input, the picture image may not be displayed correctly, or a black background may be displayed.

Display mode name	No. of dots (H x V)	Vertical scanning frequency (Hz)
VGA70	640 X 400	70.1
VGA60	640 X 480	59.9
SVGA60	800 X 600	60.3
XGA60	1024 X 768	60.0

Note: The number of dots for this Projection Television is 800 × 600 for NORMAL display. Number of dots other than 800 × 600 in the above data, will be converted to 800 × 600 (with the exception of MAC 16, which will be displayed in 832 × 624 dots).

VCR Connection

Note: The remote control must be programmed with supplied codes to operate the optional equipment.

Follow this diagram when connecting your television to a VCR only.

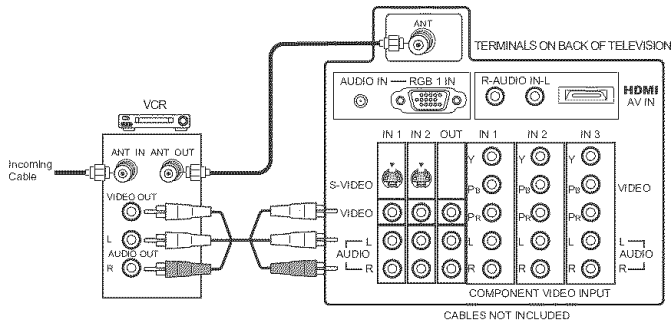

Viewing a television program

Procedure

- Tune the television to the program you want to view.

Viewing a video

Procedure

- Option A
 - Press the **TV/VIDEO** button on the remote control to select the video input (VIDEO 1, VIDEO 2, etc.) connected to your VCR.
 - Begin the video.
- Option B
 - Tune the television to Channel 3 or 4, depending on your VCR.
 - Begin the video.

Recording a television program

Procedure

- Option A (Recording and viewing the same program)
 - Tune the television to Channel 3 or 4, depending on your VCR.
 - Using the VCR, tune to the television program you want to record.
 - Begin recording.
- Option B (Recording one program while viewing another program)
 - Press the **TV/VIDEO** button on the remote control to select the video input (VIDEO 1, VIDEO 2, etc.) connected to your VCR.
 - Using the VCR, tune to the television program you want to record.
 - Begin recording.
 - Press the **TV/VIDEO** button on the remote control to switch back to TV mode.
 - Tune the television to the program you want to view.

Cable Box Connection

Follow this diagram when connecting your television to a cable box only.

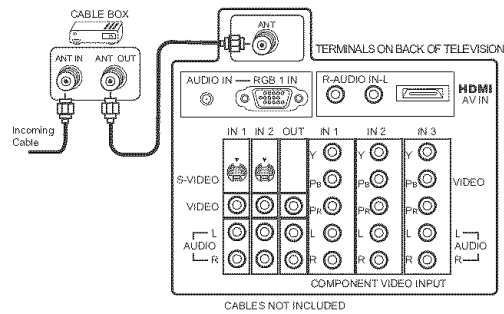

Viewing a premium (scrambled) cable channel

Procedure

- Tune the television to Channel 3 or 4 depending on cable box.
- Using the cable box, tune to the premium cable channel you want to view.

VCR and Cable Box Connection

Follow this diagram when connecting your television to both a VCR and a cable box.

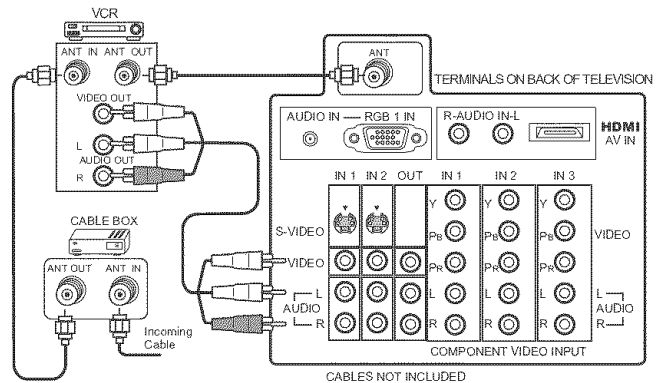

Viewing a premium (scrambled) cable channel

Procedure

- Tune the television to Channel 3 or 4 depending on cable box.
- Using the cable box, tune to the premium cable channel you want to view.

Recording a premium (scrambled) cable channel

Procedure

- Press the **TV/VIDEO** button on the remote control to select the video input (VIDEO 1, VIDEO 2, etc.) connected to your VCR.
- Turn the VCR ON.
- Tune the VCR to Channel 3 or 4, depending on the switch setting on the back of VCR.
- Using your cable box, tune to the premium cable channel you want to record.
- Begin recording.
- To view a different channel while recording:
 - Press the **TV/VIDEO** button on the remote control to select TV mode.
 - Tune the television to a program (except another premium cable channel).

Amplifier Connection

To listen through a separate stereo system, connect an external audio amplifier to OUT L/R AUDIO outputs on back of television.

Note: AUDIO AMP terminals cannot be connected directly to external speakers.

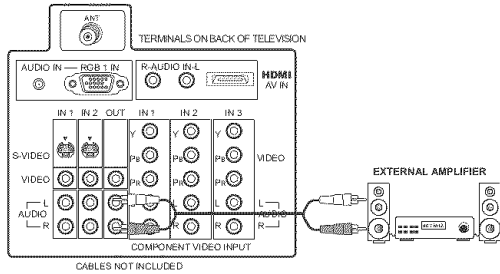

Audio Adjustments

- Select SPEAKERS ON located in the onscreen AUDIO menu.
- Set amplifier volume to minimum.
- Adjust television volume to desired level.
- Adjust amplifier volume to match the television.
- Select SPEAKERS OFF & VARIABLE AUDIO OUT from AUDIO menu.
- Volume, mute, bass, treble and balance are now controlled through the television.

Note: Select SPEAKERS OFF & FIXED AUDIO OUT to control audio functions through the external amplifier.

Digital TV - Set-Top Box (DTV-STB) or DVD Connection

This television is capable of displaying 1080i, 720p and 480p DTV signals when connected to a DTV tuner set-top-box (STB). In order to view DTV programming, the STB must be connected to the component video inputs (Y, P_B, P_R) of the television. A DTV signal must be available in your area. Select the output of the STB to either 1080i, 720p or 480p.

This television also utilizes a progressive scan doubler, which de-interlaces the NTSC signal and progressively scans the image.

Use this diagram to connect the DTV-STB or DVD player to the back of your projection television.

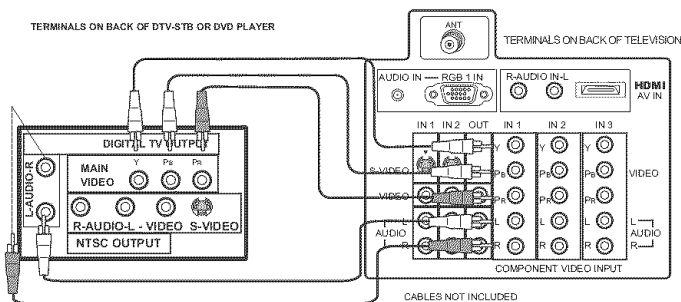

Note: There are three sets of three video jacks, Y, P_B, and P_R. Separate component color inputs provide luminance and color separation. Use the L (left) and R (right) audio inputs.

Program Out Connection

To use the television audio and video with optional equipment, connect the Video Out and AUDIO L/R connections on the back of the television.

Note: If the main picture signal is component video input, HDMI, JPEG or RGB no Program Out signal will be available.

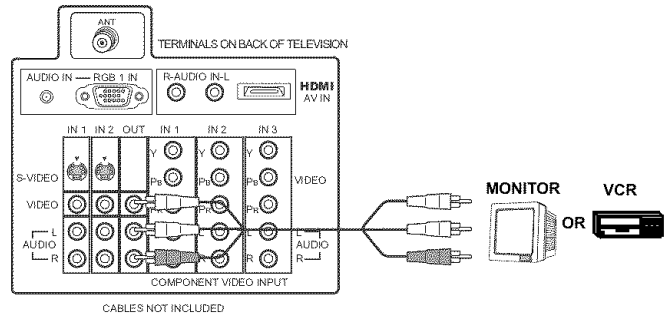

Procedure

- Connect optional equipment to VIDEO OUT and AUDIO L/R terminals.
- VIDEO OUT terminal display is the same as on-screen display.
- See optional equipment manual for further instructions for recording and monitoring.

ENGLISH

HDMI (High Definition Multimedia Interface) Input Connection

About HDMI

HDMI is the first all-digital consumer electronics A/V interface that supports several uncompressed standards, enhanced and high definition video formats as well as existing multi-channel audio format. One jack supports both video and audio information. The HDMI/HDCP¹ input can be connected to an EIA/CEA 861² compliant consumer electronic device, such as a set top box or DVD player equipped with an HDMI or DVI output connection. By inputting a HDCP high definition picture source to the HDMI terminal of this Projection Television, high definition pictures can be displayed on the screen in their digital form. The HDMI input terminal is not intended to be used with personal computers. This Projection Television is compatible with 1080i, 720p, 480p and 480i formats. Select the output of the connecting device to match that of the Projection Television.

Notes:

1. HDMI/HDCP = High Definition Multimedia Interface / High-Bandwidth Digital Copy Protection.
2. EIA/CEA-861 = Compliance covers profiles for transmission of uncompressed digital video including high bandwidth digital content protection.

Compatible formats

This Projection Television is compatible with the following formats. Please set the connecting device to the following format.

Video signal

Format	No. of pixels	Vertical scanning frequency (Hz)
1080i	1920 x 1080i	59.94 / 60
720p	1280 x 720p	59.94 / 60
480p	720 x 480p 640 x 480p	59.94 / 60 59.94 / 60
480i	720 x 480i	59.94 / 60

Audio signal

When digital audio is included in the HDMI connection, the compatible sampling frequencies are 48 KHz / 44.1KHz / 32 KHz.

Connection diagram

Follow the diagram below to connect the Projection Television to a set top box or a DVD player.

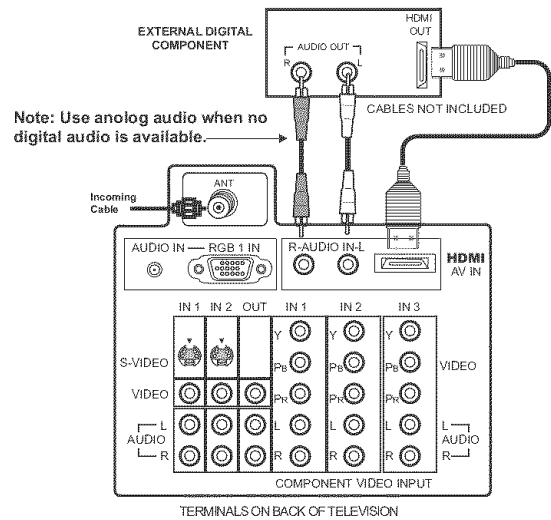

* The connector on the Projection Television is HDMI Type A connector.

Procedure

- Connect the HDMI output from the set top box or a DVD player to the HDMI input on the back of the Projection Television.
- Press TV/VIDEO button on the remote control to select HDMI input. The interface on the Projection Television is an HDMI Type A connector.
- If the external device has a DVI output only, use a DVI to HDMI adaptor cable*³ to connect to the HDMI jack on the Projection Television. Also, connect the Audio Out signal from the external device (set top box or DVD player) to the Audio In*⁴ jacks below the HDMI input.
- If you cannot display the picture because your Digital Set Top Box does not have a Digital Out terminal setting, use the Component Video Input (or the S-Video Input or Video Input). In this case, the picture will be displayed as an analog signal.

Notes:

*3. **HDMI-DVI conversion cable (TY-SCH03DH) available on Panasonic Website: www.panasonic.com (for USA only).**

*4. Please refer to page 22 for Audio setting detail.

Special Features

ASPECT Button

Note: Aspect is not available while in RGB and HDMI mode.

Customer Options depending on Component Input Signal

INPUT SIGNAL	DISPLAY ON SCREEN	ASPECT BUTTON OPTIONS
1080i 720p	16:9 only	No options
480p (16:9)	Default to 16:9	4:3, Full or Zoom (see below)
480p (4:3)	Default to FULL mode. Note: Will stretch picture horizontally.	4:3, Full or Zoom (see below)
480i	Default to JUST mode	4:3, Full, Just or Zoom (see below)

The **ASPECT** button on the remote control lets you choose one of four display modes, depending on the formats of the received signal and your preferences.

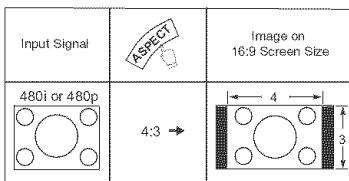

The 4:3 mode will display a 4:3 picture at its standard 4:3 size with black side bars.

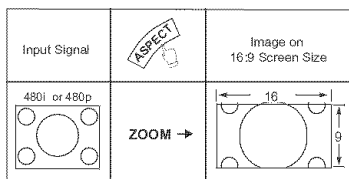

Zoom will expand the 4:3 picture uniformly (width and height) to full screen width and then reposition the picture vertically. (Recommended for letterbox pictures.)

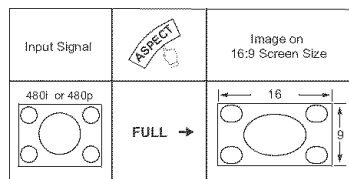

FULL will show picture at full screen size. (Recommended for anamorphic pictures.)

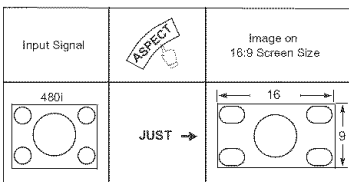

JUST(justified) will stretch the right and left edges of a 4:3 picture to fill the screen, The center of the picture will be normal (not stretched)The size of the picture will depend on the original signal. (Recommended for regular TV viewing.)

BBE Button

Press this button to turn BBE VIVA 3D sound feature On or Off.

SAP Button

Press this button to let you cycle through different audio modes. For example:

- If receiving STEREO, SAP and MONO or receiving STEREO and MONO only, pressing SAP button will toggle the audio as follows:

▶ STEREO → SAP → MONO

Split-Screen Operation

Note: Split-Screen is not available while in RGB and HDMI mode.

This feature lets you watch two different signal sources side by side with or without an external video source.

Note: Main picture and Split frame cannot display the same picture.

Procedure

- Press **SPLIT** to display Split frame.
- Choose channels for the SPLIT frame by pressing **SPLIT CH DVD/VCR CH**, to use the remote control numeric keypad **▼** **▲**

to change channel in Split frame. Press **SPLIT CTRL.** **▶▶**, then the right indicator (**▶▶**) will appear.

Note: Numeric keypad can only be used for split frame while right indicator (**▶▶**) is displayed.

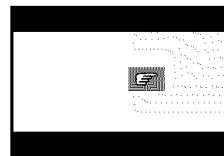

Change Split Frame channel with numeric keypad.

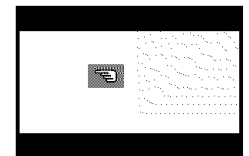

Change Main Picture channel with numeric keypad.

- Select channels for the Main picture by pressing **▲** or **CH** or use the remote control numeric keypad.
- Press **SWAP** to switch the SPLIT FRAME and MAIN PICTURE source.
- Press **RECALL** to view picture source status.
- Press **SPLIT** to cancel Split frame.

Split-Screen Operation With a Cable Box

To view premium (scrambled) cable channels through your cable box in the Main Picture:

Note: Use this procedure if you want to watch premium cable channels in the Main Picture while viewing a television program or video in the Split frame.

Procedure

- Tune TV to channel 3 or 4.
 - Press **SPLIT** on the remote control to display Split frame.
- Note:** Audio is from the Main Picture only.
- Verify that the cable box is ON.
 - Choose channels for the Main Picture by tuning the cable box.
 - Choose channels for the SPLIT frame by pressing

SPLIT CH DVD/VCR CH.
▼ **▲**

Split-Screen Operational Buttons

SPLIT CTRL Button

Pressing **SPLIT CTRL.** will enable you to use numeric keys for changing split channel and to use TV/VIDEO button to select desired input for Split frame.

TV/VIDEO Button

Press when Split frame is displayed to select desired input mode.

Procedure

- Press **SPLIT** to display Split frame.
- Press **SPLIT CTRL.** then **TV/VIDEO** to display video input menu.
- Press corresponding number key on the remote control to select the input of your choice.

Note: Split frame input mode can only be changed while right indicator () is displayed.

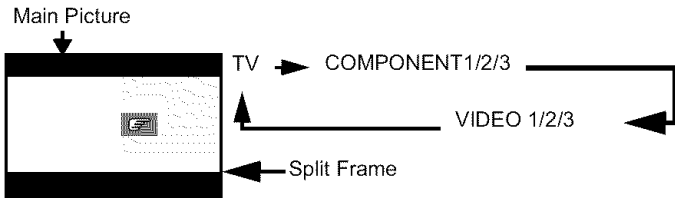

Search Button

This feature lets you scan through all available channels.

Procedure

- Press **SPLIT** to display split frame.
- Press **SEARCH** to display search frames.
- Press **SEARCH** again to stop search feature. Split frame channel will be the last active search frame.
- Press **SPLIT** to cancel split frame.

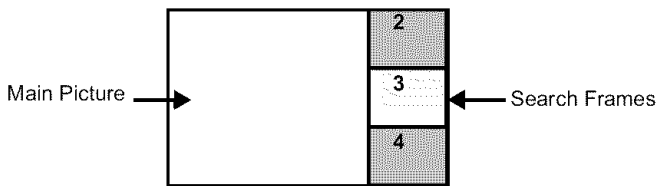

Note: When main picture is Photo Viewer™, Component, RGB or HDMI signal, search feature is not available.

Freeze Button

This feature is used to stop action in Split frame.

Procedure

- Press **SPLIT** to display split frame.
- Press **FREEZE** to stop split frame action.
- Press **FREEZE** again to continue action.
- Press **SPLIT** to cancel frame.



Main Picture Freeze Feature

This feature is used to stop action of the Main Picture and display it on a Split freeze frame.

Procedure

- To stop action for Main picture, press **FREEZE** while Split frame is not displayed.
- Main Picture freeze will be displayed in Split frame.
- Press **FREEZE** again to cancel Main Picture freeze frame.

Note: While Main Picture freeze frame is displayed, only FREEZE button is active for Split frame. All other Split buttons have no effect.

Direct Video Input Selection

This feature lets you select video inputs directly using the TV/VIDEO and the numeric keys on the remote control.

Procedure

- Press **TV/VIDEO** on the remote control to display the Input selection menu.



- Press corresponding number key on the remote control to select the input of your choice.

Note: Video input can also be selected by pressing **TV/VIDEO**, then the CH ▲▼ buttons.

Remote Control Operation

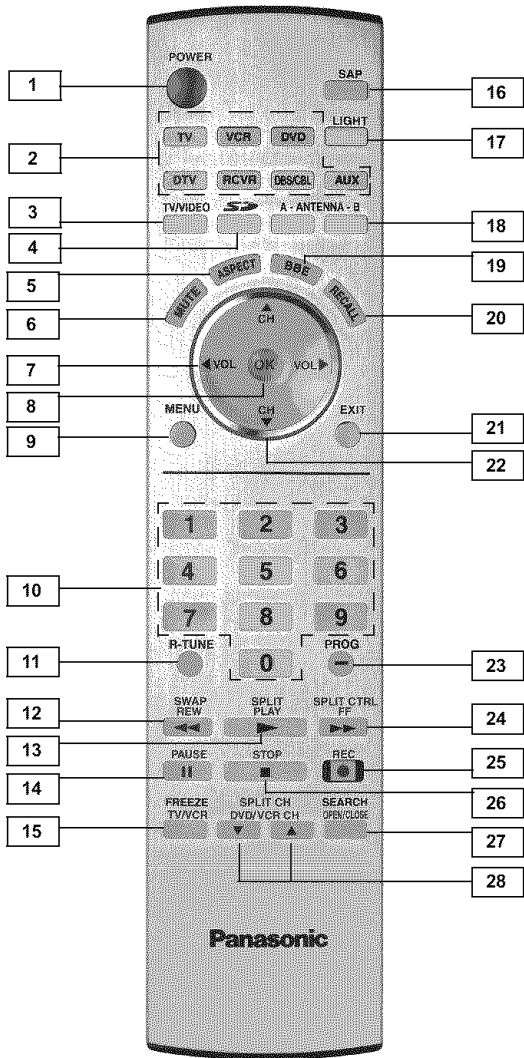

EUR7627Z20

BUTTON NUMBER	DESCRIPTION
1	Press to turn ON and OFF. <i>Note:</i> The ON/OFF indicator LED (green) on the Projection Television will be lit when the Projection Television is on.
2	Press to select TV, VCR or other device to operate.
3	Press to select TV or input modes for main picture or split frame. <i>Note:</i> Refer to TV/VIDEO Button section on page 14 for selecting split frame input.
4	Press to access Photo Viewer. Also press while Photo Viewer is displayed to access Photo Viewer set up menu.
5	Press to select picture shape to match programming format. Also used for Photo Viewer to change aspect of the image on-screen while in slide mode.
6	Press to mute sound.

BUTTON NUMBER	DESCRIPTION
7	Press to adjust Projection Television sound and navigate in menus.
8	Press to choose menu and sub-menu entry.
9	Press to display Main Menu or return one step backward in menus.
10	Press numeric keypad to select any channel or press to enter alphanumeric input in menus.
11	Press to switch to previously viewed channel or input mode.
12	Press to swap Main picture with Split frame. REW - While remote is in VCR or DVD mode, press to rewind.
13	Press to display Split frame, press again to delete Split frame. While remote is in VCR or DVD mode, press to play.
14	While remote is in VCR or DVD mode, press to pause.
15	FREEZE - While in TV mode, press to stop action in the Split frame. TV/VCR - Press to switch to TV or VCR.
16	Press to access audio modes (Stereo, SAP or Mono).
17	Press to illuminate remote buttons.
18	These buttons are not operational for this model.
19	Press to turn BBE VIVA 3D OFF or ON.
20	Press to display or delete Channel banner.
21	Press to exit menus.
22	Press to change channels and navigate in menus.
23	Press after entering major channel numbers to enter minor (-) channel numbers.
24	Press to use numeric keypad and TV/VIDEO buttons for Split operation. FF - While in VCR or DVD mode, press to fast forward.
25	While remote is in VCR mode, press to record.
26	While remote is in VCR or DVD mode, press to stop.
27	SEARCH - Press to scan available channels in search frames. Press again to delete search frames. OPEN/CLOSE - Press to open or close DVD tray.
28	Press to change channels for Split frame or VCR. Also press to change chapter for DVD.

ENGLISH

Programming The Remote

The Universal Remote Control can be programmed to operate many manufacturers' components, using the component function buttons for VCR, DVD, AUX, RCVR, DTV, CABLE or DBS. Follow the procedures for programming your Remote Control with or without a code for the component.

Device	Operates	Default
TV	TV (Panasonic Only)	Panasonic Code
VCR	VCR (Preset)	Panasonic Code
DVD	DVD and CD (Preset)	DVD Panasonic Code
DBS/ CABLE	DBS & CBL (Preset)	Panasonic DBS Code
RCVR	Audio Receiver (Preset)	Panasonic RCVR Code
DTV	DTV (Panasonic Only)	Panasonic DTV Code
AUX	Personal Video Recorders, Cassette and VCR2	Panasonic Personal Video Recorder Code

Note: Determine the manufacturer of the component and look in the table for the code.

Procedure

1. Confirm that the external component is plugged and operating.
2. Turn the component off.
3. Press and together, **for at least 5 seconds**. After 5 seconds, the illuminated mode (component) buttons will begin to flash. Release the OK and POWER buttons.
4. Press appropriate component button on the Remote Control VCR, DVD (CD), DTV, RCVR, DBS/CBL or AUX (PVR or VCR2). The component button will illuminate steadily and all others will go out.
5. Enter the 3-digit component code using the Remote Control numeric keypad (0 ~ 9 buttons). The component button will blink twice.
6. Press the Remote Control to test the component. If the procedure was successful, the component will turn on and the component key will blink twice and then go out.

Note: If the component does not operate with the Remote Control, repeat steps 3 through 6 using another code. (Some brands have multiple codes.) If an incorrect code is entered, or if the procedure takes longer than 30 seconds, the programming will fail.

Programming Without A Code

This procedure searches all codes and is called the "sequence method."

1. Confirm that the external component is plugged in and on.
2. Turn the component off.
3. Press and together, **for at least 5 seconds**. After 5 seconds, the illuminated mode (component) buttons will begin to flash. Release the OK and POWER buttons.
4. Press appropriate component button on the Remote Control.
5. Press the button to place the remote control into the step and set mode.
6. Point the remote control towards the component.
7. Press **VOL** (the mode key will blink three times), then

press the Remote Control to test the component. Continue this process until the proper code is found. If the procedure was successful, the component will **turn on**.

Note: Each time you press the VOL button, make sure that the component key blinks twice before pressing the POWER button.

8. Once the device responds, press to store the code. The mode (component) button will blink twice.

Note: It may take many attempts before the correct code is found. If you miss a code, press VOL, then press

the button to test the component.

Component Codes

The Universal Remote Control is capable of operating many component brands after entering a code. Some components may not operate because the codes are not available due to limited memory. The Universal Remote Control does not control all features found in each model.

Write the code numbers from tables in this space. This will serve as a reference if you need to program your Remote Control.		
VCR <input type="text"/> <input type="text"/> <input type="text"/>	DVD <input type="text"/> <input type="text"/> <input type="text"/>	DVD (CD) <input type="text"/> <input type="text"/> <input type="text"/>
DBS <input type="text"/> <input type="text"/> <input type="text"/>	RECEIVER <input type="text"/> <input type="text"/> <input type="text"/>	CABLE <input type="text"/> <input type="text"/> <input type="text"/>
AUX (PVR) <input type="text"/> <input type="text"/> <input type="text"/>	AUX (VCR2) <input type="text"/> <input type="text"/> <input type="text"/>	

Codes For VCR	
Brand	Code
Admiral	335
Aiwa	332
Akai	314, 315, 316, 329
Audio Dynamic	311, 339
Bell & Howell	305, 313
Broksonic	320, 326
Canon	323, 325
CCE	343
Citizen	306
Craig	305, 306, 329
Curtis Mathes	324, 345
Daewoo	301, 324, 343
DBX	310, 311, 339
Dimensia	345
Emerson	303, 319, 320, 325, 326, 343
Fisher	305, 307, 308, 309, 313
Funai	320, 326, 334
GE	324, 333, 345
Goldstar	306
Gradiente	334
Hitachi	300, 323, 345
Instant Replay	323, 324
Jensen	339
JVC	310, 311, 334, 339
Kenwood	306, 310, 311, 339
LXI	300, 305, 306, 307, 308, 309
Magnavox	323, 324, 331
Marantz	310, 311, 339
Marta	306
Memorex	309, 324
MGA	338, 340, 341, 347, 348
Minolta	300, 345
Mitsubishi	338, 340, 341, 347, 348
Multitech	304, 347
NEC	310, 311, 334, 339
Olympic	323, 324
Optimus	306, 321, 328, 335
Orion	320, 326
Panasonic	321, 322, 323, 324
Penney	300, 305, 310, 311, 324, 339, 345
Pentax	300, 311, 345

Codes For VCR (Cont.)	
Brand	Code
Philco	320, 323, 324, 326, 331, 343
Philips	323, 324, 331
Pioneer	323
Proscan	300, 301, 302, 323, 324, 331, 333, 345, 346
Quasar	321, 322, 323, 324
Radio Shack	305, 309, 324, 333, 336, 340
RCA	300, 301, 302, 323, 324, 331, 333, 345, 346
Realistic	305, 309, 324, 336, 340
Samsung	302, 304, 333
Sansui	320, 326, 339, 352
Sanyo	305, 309, 313
Scott	301, 302, 304, 309, 320, 326, 338, 340, 347, 348
Sears	300, 305, 306, 307, 308
Sharp	335, 336
Shintom	317
Signature 2000	335
Singer	337
Sony	328, 329, 330
Sylvania	323, 324, 331
Tashiro	306
Tatung	310, 311, 339
Teac	310, 311, 339
Technics	321, 322, 323, 324
Teknika	324
Toshiba	301, 346
Vector Research	311
Wards	306, 309, 335, 336, 344
Yamaha	305, 310, 311, 339
Zenith	306, 344

Codes For Cable Box	
Brand	Code
ABC	224
Archer	225, 232
Cableview	205, 232
Citizen	205, 222
Curtis	212, 213
Diamond	224, 225, 232
Eagle	229
Eastern	234
GCbrand	205, 232
Gemini	222
General Instrument/ Jerrold	211, 219, 220, 221, 222, 223, 224, 225, 226, 227
Hamlin	212, 218, 240, 241, 242, 245
Hitachi	203, 224
Macom	203, 204, 205
Magnavox	233
Memorex	230
Movietime	205, 232
Oak	202, 237, 239
Panasonic	209, 210, 214
Philips	206, 207, 228, 229, 230
Pioneer	201, 216
Pulsar	205, 232
Puser	232
RCA	215
Realistic	232
Regal	212, 218, 240, 241, 242, 245,
Regency	234
Rembrandt	205, 232, 237
Samsung	205
Scientific Atlanta	211, 212, 213
Slmark	201, 205
Sprucer	205, 210
Stargate	205, 232
Teleview	201, 205
Texscan	244
Tocom	235
Toshiba	204
Unika	225, 232
Universal	122, 132
Videoway	106
Viewstar	129, 130
Zenith	100, 117
Zenith/Drake Satellite	100

Codes For DBS	
Brand	Code
Dish Network (Echostar)	105, 115, 116
Echostar	105
Express VU	105, 115
G. E.	106
G.I. (General Instrument)	108
Gradiente	114
Hitachi	103, 111, 112
HNS (Hughes)	103
Magnavox	101, 102
Panasonic	104
Philips	101, 102
Primestar	108
Proscan	106, 109, 110, 113
RCA	106, 109, 110, 113
Sony	107
Star Choice	103, 108
Toshiba	100
Uniden	101, 102
Zenith	127

Codes For DVD	
Brand	Code
Denon	100
Ferguson	101
JVC	109
Mitsubishi	105
Nordmende	101
Panasonic	100
Philips	103
Pioneer	102
RCA	101
Saba	101
Samsung	110
Sharp	108
Sony	104
Technics	100
Thomson	101
Toshiba	103
Yamaha	100
Zenith	107

Component Codes (Cont.)

ENGLISH

Codes For Cassette Decks	
Brand	Code
Aiwa	223, 224, 225
Denon	231
Fisher	203
Jensen	214
JVC	229, 230
Kenwood	200, 207
Marantz	202
Nakamichi	205
Onkyo	208, 209, 213
Panasonic	216, 218
Philips	222
Pioneer	204
RCA	226, 227, 228
Sansui	205, 210
Sharp	231
Sony	219, 220
Teac	210, 211, 215
Technics	216, 218
Yamaha	201, 202

Codes For Receivers	
Brand	Code
Admiral	120
Aiwa	125, 126
Denon	134, 135, 136
Fisher	104
Garrard	113
Harman/Kardon	115, 123
Jensen	129
JVC	132, 133
Kenwood	100, 108
Magnavox	127
Marantz	124
McIntosh	116
Nakamichi	106
Onkyo	109, 114
Optimus	103, 127, 130, 131
Panasonic	118, 119, 121
Philips	123
Pioneer	105, 107
Quasar	118, 119, 121
RCA	103, 105, 127, 130, 131
Sansui	103, 111, 139
Sharp	134, 137
Sony	122
Soundesign	138
Teac	111, 112, 113
Technics	118, 119, 121
Victor	132, 133
Yamaha	101, 102

Codes For CD Player	
Brand	Code
Admiral	226
Aiwa	233, 235
Carver	229
Denon	242
Emerson	239
Fisher	205
Harman/Kardon	219, 220, 221, 223
Hitachi	207
Jensen	234
JVC	240, 241, 245
Kardon	223
Kenwood	200, 201, 211, 245
LXI/Sears	236
Magnavox	229, 232
Marantz	229
McIntosh	221
Nakamichi	210
Onkyo	214, 215
Optimus	208, 218, 220, 222
Panasonic	224, 225, 227
Philips	229, 230
Pioneer	208
Quasar	224, 225, 227
RCA	231, 237, 238, 247
Sansui	210, 246
Sanyo	205
Scott	210, 246
Sharp	242, 243
Sherwood	220
Sony	228
Soundesign	244
Teac	212, 216, 218
Technics	224, 225, 227
Victor	240, 241, 245
Yamaha	202, 203, 204

Codes For Personal Video Recorders	
Brand	Code
Panasonic Replay TV	100
Philips Tivo	102
Sony Tivo	101

Operating Components with Remote Control

Note: Refer to page 16 for programming Remote Control procedure.

Operating a VCR

Program the remote control to use with VCR.

TO DO THIS...	PRESS	TO DO THIS...	PRESS
Turn on/off	POWER	Rewind the Tape	SWAP REW
Select TV Input mode for VCR	TV/VIDEO	Fast Forward	SPLIT CTRL FF
Change Channels up/down	CH CH	Select a Channel	1 2 3 4 5 6 7 8 9 0
Change Channels up/down	SPLIT CH DVD/VCR CH	Pause	PAUSE
Record	REC	Change to TV or VCR Mode	FREEZE TV/VCR
Play	SPLIT PLAY	On screen VCR Display	RECALL
Stop	STOP		

Operating a DBS

Program the remote control to use with DBS.

TO DO THIS...	PRESS	TO DO THIS...	PRESS
Turn on/off	POWER	Navigation left/right	VOL VOL
STB Audio track	SAP	STB Action	OK
Navigation up/down	CH CH	Select a Channel	1 2 3 4 5 6 7 8 9 0
STB Change Channels up/down	SPLIT CH DVD/VCR CH	Previous Channel	R-TUNE
STB Aspect	ASPECT	STB select dash channel	PROG
STB Menu	MENU	STB search	SEARCH OPEN/CLOSE
STB Exit	EXIT	STB M. guide	SWAP REW
STB program info	RECALL	STB jump	SPLIT CTRL. FF
STB FAV	SPLIT PLAY	Select TV input for DBS	TV/VIDEO
STB Record	REC		

TO DO THIS...	PRESS	TO DO THIS...	PRESS
Change to TV or SAT Mode	FREEZE TV/VCR		

Operating a DVD

Program the remote control to use with DVD

TO DO THIS...	PRESS	TO DO THIS...	PRESS
Turn on/off	POWER	Skip search<<	SWAP REW
Navigation left/right	VOL VOL	Skip search>>	SPLIT CTRL. FF
Navigation up/down	CH CH	Select chapter	1 2 3 4 5 6 7 8 9 0
Ch +/-	SPLIT CH DVD/VCR CH	Still/Pause	PAUSE
Record	REC	Select	OK
Play	SPLIT PLAY	DVD Display	RECALL
Stop	STOP	Menu	MENU
Open/Close	SEARCH OPEN/CLOSE	Title	R-TUNE
Select TV input for DVD	TV/VIDEO	Return	EXIT

Operating a CD

Program the remote control to use with CD.

TO DO THIS...	PRESS	TO DO THIS...	PRESS
Turn on/off	POWER	Play	SPLIT PLAY
Time format	RECALL	Select Tracks	1 2 3 4 5 6 7 8 9 0
Next/previous track	CH CH	Search Rew	SWAP REW
Random / repeat.	SPLIT CH DVD/VCR CH	Next disk	R-TUNE
Search FF	SPLIT CTRL. FF	Still/pause	PAUSE
Stop	STOP	Open/Close	SEARCH OPEN/CLOSE

REMOTE CONTROL OPERATION

Operating a DTV Set Top Box

Program the remote control to use with DTV.

TO DO THIS...	PRESS	TO DO THIS...	PRESS
Turn on/off	POWER 	Program Information	RECALL
SAP	SAP 	TV input for DTV	TV/VIDEO
Navigation up/down	CH CH 	Select Channel	1 2 3 4 5 6 7 8 9 0
Navigation left/right	VOL VOL 	Select dash number	PROG
Aspect	ASPECT 	Record	REC
DTV Action	OK 	Menu	MENU
Exit	EXIT 	Previous Channel	R-TUNE

Operating a Receiver

Program the remote control to operate audio receiver.

TO DO THIS...	PRESS	TO DO THIS...	PRESS
Turn on/off	POWER 	Volume +/-	VOL VOL
Audio Mute	MUTE 	To select AV input or Components	Press Remote numeric keypad AV1 Press 1 AV2 Press 2 AV3 Press 3 AV4 Press 4 CD Press 5 TUNER Press 6 PHONO Press 7 TAPE Press 8 AUX Press 9
Switch input	TV/VIDEO 	Surround -	SWAP REW
Tuner +/-	CH CH 	Surround +	SPLIT CTRL FF
Center-/+	SPLIT CH DVD/VCR CH 		

Operating a PVR (Personal Video Recorder)

Program the remote control to use with a PVR.

TO DO THIS...	PRESS	TO DO THIS...	PRESS
Turn on/off	POWER 	Rewind	SWAP REW
Select TV/VCR	TV/VIDEO 	Fast Forward	SPLIT CTRL FF

TO DO THIS...	PRESS	TO DO THIS...	PRESS
PVR up/down	CH CH 	Select a Channel	1 2 3 4 5 6 7 8 9 0
PVR left/right	VOL VOL 	Pause	PAUSE
Change Channels up/down	SPLIT CH DVD/VCR CH 	Replay zone	R-TUNE
PVR select	OK 	Instant replay	FREEZE TV/VCR
Record	REC 	Return to live	PROG
Play	SPLIT PLAY 	Quick skip	SEARCH OPEN/CLOSE
Stop	STOP 	Exit	EXIT
Menu	MENU 		
Enter	RECALL 		

Operating a Cassette Deck

To operate a cassette deck, the remote control must be in AUX mode and be programmed with the appropriate code for your equipment.

TO DO THIS...	PRESS	TO DO THIS...	PRESS
Turn on/off	POWER 	Rewind	SWAP REW
Record	REC 	Fast Forward	SPLIT CTRL FF
Play	SPLIT PLAY 	Pause	PAUSE
Stop	STOP 	Open/Close	SEARCH OPEN/CLOSE
Deck A/B	R-TUNE 		

Operating a CABLE BOX

Program the remote control to use with Cable Box.

TO DO THIS...	PRESS	TO DO THIS...	PRESS
Turn on/off	POWER 	Volume up/down	VOL VOL
Audio Mute	MUTE 	Enter	OK
Change Channels up/down	CH CH 	Select a Channel	1 2 3 4 5 6 7 8 9 0
Change Channels up/down	SPLIT CH DVD/VCR CH 	Previous Channel	R-TUNE

Basic Menu Navigation

Press **MENU** to display the Main Menu.

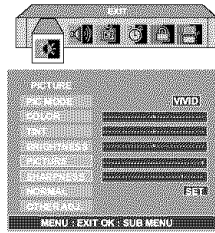

Press to choose the desired icon.



Press to enter the sub-menu field.

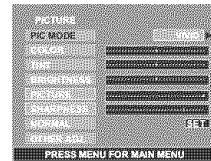

sub Menu Field

Press to select desired sub-menu.

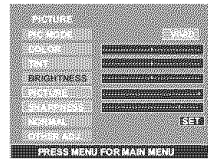

Press to select or adjust desired sub-menu.

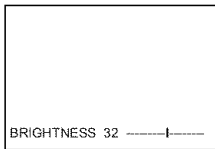

Note: For sub-menu with OTHER ADJ.

Press to select OTHER ADJ.



Press to enter sub sub-menu field.

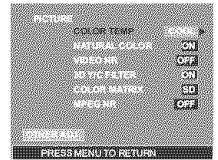

sub sub-Menu Field

Press to select desired sub sub-menu.



Press to select or adjust desired sub sub-menu.

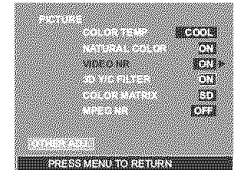

Note: To EXIT menus.

OR Press **EXIT** to exit all menu.

Press **MENU** repeatedly until Main Menu Icon is highlighted.

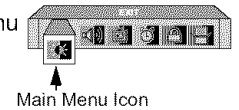

Main Menu Icon

Press to exit Main Menu.

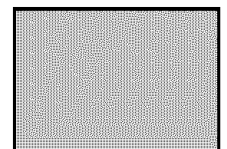

NORMAL PICTURE

ENGLISH

Icon Menu Operation

PICTURE

Note: While sub-menu features are highlighted, press **VOL ▶** to adjust or activate.

- ❑ PIC MODE - Lets you choose one of three pre-set Picture Modes that best suits the program you are viewing. Selecting this feature will also affect Color Temperature setting.

PIC MODE - COLOR TEMP DEFAULT SETTINGS

PIC MODE	COLOR TEMP
VIVID	COOL
STANDARD	NORMAL
CINEMA	WARM

Note: Each mode has its own picture settings (Color, Tint, Brightness, Picture and Sharpness) and Color Temp settings.

- VIVID - This is the default mode, It provides enhanced picture contrast and sharpness for viewing in a well-lit room.
- STANDARD - Recommended for normal viewing conditions with subdued room lighting.
- CINEMA - Select this mode for watching movies in a darkened room. It provides a soft, film-like picture.

Notes:

- When in RGB input mode, Cinema will change to Photo.
- When in Photo viewer mode Pic mode will default to Photo and will not be selectable.

- ❑ COLOR - Adjusts desired color intensity.
- ❑ TINT - Adjusts natural flesh tones.
- ❑ BRIGHTNESS - Adjusts dark areas of picture.
- ❑ PICTURE - Adjusts white areas of picture.
- ❑ SHARPNESS - Adjusts clarity of outline detail.
- ❑ NORMAL - Reset each of the PIC Mode adjustments to factory default settings.

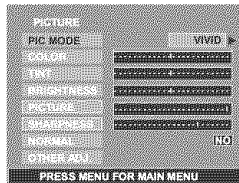

❑ OTHER ADJ.

Highlight OTHER ADJ. and press **VOL ▶** to display the sub sub-menu.

Note: While sub sub-menu features are highlighted, press **VOL ▶** to select or activate.

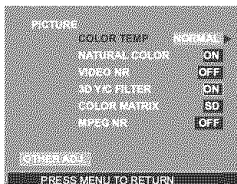

- COLOR TEMP (temperature) - To increase or decrease WARM (red) and COOL (blue) colors to suit personal preferences.
- NATURAL COLOR - To increase the color reproduction range with natural color gradation and highly delicate hues.

- VIDEO NR - Reduces noise in the black-and-white portion of the video signal.
- 3D Y/C FILTER - Minimizes color noise and cross color in the picture.
- COLOR MATRIX - Available only with 480p signal. Select HD or SD to automatically adjust color parameters for HD (high definition) and SD (standard definition). This feature is not selectable when viewing a regular TV (NTSC) program.

Note: When viewing a non-standard DTV signal format, you can change color parameters manually for the best picture quality.

- MPEG NR - This feature reduces the block noise caused by the MPEG video compression used in DVD and HDTV sources.

AUDIO

Note: While sub-menu features are highlighted, press **VOL ▶** to adjust or activate.

- ❑ MODE - Select STEREO, SAP (Second Audio Program) or MONO. (Use MONO when stereo signal is weak).
- ❑ BASS - Increase or decrease the low-frequency response.
- ❑ TREBLE - Increase or decrease the high-frequency response.
- ❑ BALANCE - Emphasize the left/right speaker volume.
- ❑ NORMAL - Reset BASS, TREBLE and BALANCE adjustments to factory default settings.

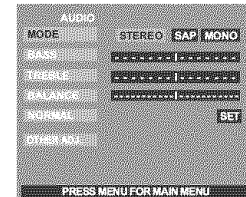

❑ OTHER ADJ.

Note: While sub-menu features are highlighted, press **VOL ▶** to adjust or activate.

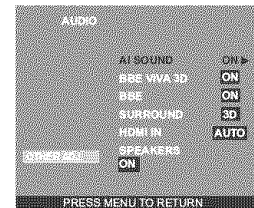

- AI SOUND - Equalize overall volume levels across all channels.
- BBE VIVA 3D - BBE VIVA provides a musically accurate natural 3D image with hi-fi sound. The clarity of the sound is improved by BBE while the width, depth and height of the sound image are expanded by BBE's proprietary 3D sound processing. BBE VIVA is compatible with all TV programs including news, music, dramas, movies and sports as well as electronic games. BBE VIVA enhances the surround sound effect, while maintaining the clarity of dialogue.
- BBE® - BBE High Definition Sound restores clarity and presence for better speech intelligibility and music realism.

AUDIO (cont.)

OTHER ADJ. (cont.)

- SURROUND - Enhances audio response when listening to stereo.
- HDMI IN - When using HDMI, this feature will let you switch between Analog Input and Digital Input.
 - Auto - Automatically selects Analog / Digital signal.
 - Digital - Digital Input only.
 - Analog - Analog Input only.
- SPEAKERS - This feature is used when connecting to an external amplifier.
 - ON - TV speakers operate normally.
 - OFF & Variable Audio Out - TV speakers off - audio adjustable by television control.
 - OFF & Fixed Audio Out - TV speakers off - audio adjustable by the external amplifier only.

CHANNELS



CHANNEL SCAN - Select FAV or ALL.

Note: Use remote numeric keypad to select desired favorite (FAV) channels.

FAVORITES - To enter up to 16 favorite channels. Use remote control numeric keypad to select desired channels.

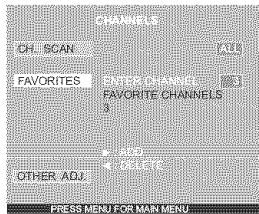

OTHER ADJ.

Highlight OTHER ADJ. and press **VOL** to display the sub sub-menu.

- PRESET CAPTION - To enter letters for popular TV stations.

Procedure

- Press **CH** to select desired preset caption.
- Then use the remote numeric keypad to select desired channel (refer to your local TV guide).

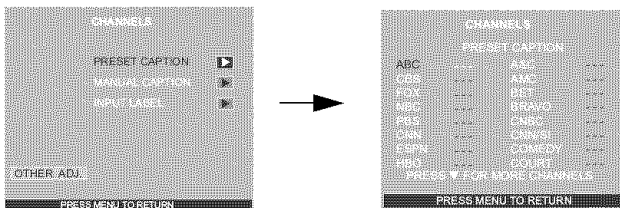

Note: To delete a channel, press **VOL** while channel number is highlighted.

- MANUAL CAPTION - To enter numbers and captions manually.

Note: Use the remote numeric keypad to select desired channel (refer to your local TV guide).

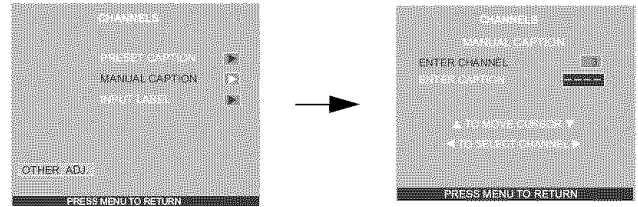

- INPUT LABEL - To label video input connections for onscreen display.

Note: Only Skip is available for RGB1 and RGB2 input label.

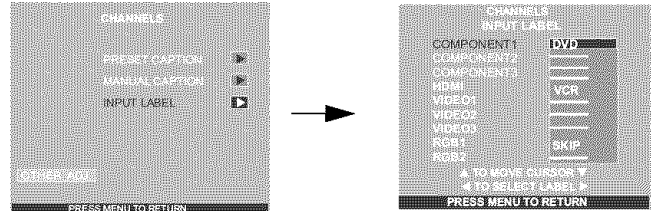

Procedure

- Press **CH** to select the desired Video input.
- Press **VOL** to select desired preset input label (see chart below).

INPUT LABEL CHART

PRESET LABELS	REASON FOR SELECTING
VCR	Select when VCR is connected to video input.
DVD	Select when DVD is connected to video input.
SKIP	Select to skip unused video input when pressing TV/VIDEO button.
CABLE	Select when CABLE box is connected to video input.
DBS	Select when DBS is connected to video input.
DTV STB	Select when digital TV set-top-box is connected to video input.
PVR (Personal Video Recorder)	Select when a personal video recorder is connected to video input.
GAME	Select when video game is connected to video input.
AUX	Select when other components are connected.
	Select to delete input label.

ENGLISH

TIMER 

Note: Use **CH ▲** or **CH ▼** to highlight and use **◀ VOL** or **VOL ▶** to select.

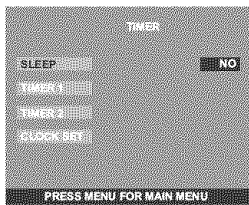

- SLEEP** - Select to turn Projection Television off in 30, 60, or 90 minutes. Select NO to turn sleep timer off.
- TIMER 1 and TIMER 2** - Select one or both timers to turn the Projection Television on and off at selected times, on a selected channel, and on selected days.

Notes:

- The television automatically turns OFF after 90 minutes when turned ON by the TIMER. If the OFF time is selected or if a key is pressed, the automatic OFF after 90 minutes will be cancelled.
- The TIMER is active when the television is OFF or ON. The television will switch to the selected channel at the selected time set in the TIMER.

- CLOCK SET** - Set the time of day and the day of the week.

LOCK 

- CREATE CODE FIRST** - Use the remote numeric keypad to enter a four-digit secret code (**Use a code that is easy to remember and record it in a safe place**).

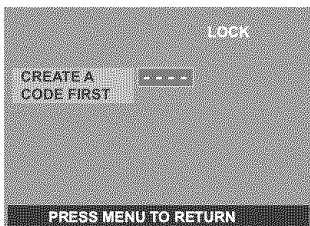

- LOCK SET** - To prevent video games, VCR tapes and all channels and video modes from being viewed.

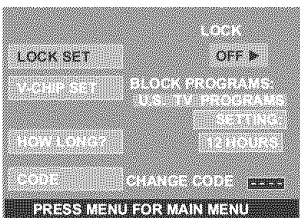

Notes:

- If you do not remember your code, LOCK will unlock in 12, 24, or 48 hours, depending on the current set-up. Be cautious when selecting ALWAYS. If ALWAYS is selected and you forget your secret code, the TV must be serviced by a qualified technician to clear the LOCK set-up.
- If you select CHANGE CODE, and you change your code from the one used in the LOCK menu, your new code becomes the controlling code.

Procedure

- Press **VOL ▶** to select.
 - OFF - Turns Lock function off.
 - GAME - Lock CH 3, 4 and Video inputs.
 - CHANNEL - Lock up to four channels.
 - ALL - Locks all channels and video inputs.

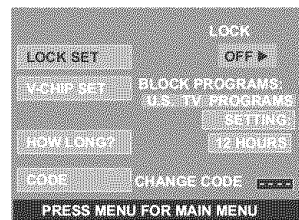

- Press **MENU** then **CH ▼** to highlight HOW LONG?.
- Press **VOL ▶** to select 12 Hours, 24 Hours, 48 Hours or ALWAYS.

Note: If **GAME, CHANNEL** or **ALL** is selected, and if a blocked channel or video input is selected, the message **LOCKED** displays in the upper left corner of the TV screen.

- V-CHIP SET** - V-Chip technology allows parents to use the Projection Television rating codes to block programs that they feel are inappropriate for their children to watch. Split will also be blocked automatically.

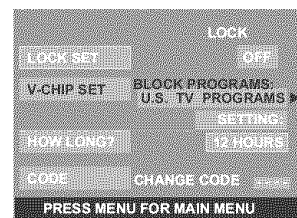

Procedure

- Press **CH ▼** to highlight Enter Code.
- Use the numeric keypad to enter your four digit code. (**Use a code that is easy to remember and record it in a safe place.**)
- Press **CH ▼** to highlight V-CHIP SET.
- Press **◀ VOL** or **VOL ▶** to select desired mode: U.S. TV Programs, U.S. Movies, Canadian English or Canadian French mode.
- Press **CH ▼** to highlight SETTING.
- Press **◀ VOL** or **VOL ▶** to display desired rating chart: U.S. TV Programs, U.S. Movies, Canadian English or Canadian French.
- Press **VOL ▶** to select ON or OFF.
- Press **CH ▼** to select VIEW NR PROGRAMS? for U.S. TV Programs and U.S. Movies or VIEW E PROGRAMS for Canadian English and Canadian French.
- Press **VOL ▶** to select YES or NO.

U.S TV Programs

This TV model features “V-Chip technology” which allows you to use U.S. TV PROGRAMS Guide ratings to block various types of TV programs. Split will also be blocked automatically.

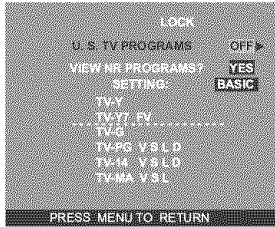

Note: By selecting “Yes”, NR programs will be received. By selecting “NO”, NR programs will be blocked (See Customer Caution below).

Procedure

- Press **CH ▼** to select SETTING.
- Press **VOL ►** to select BASIC or DETAILED.
 BASIC - Allows you to select only general ratings such as TV-Y, TV-PG, etc.
 DETAILED - Allows you to select both general ratings and content such as V, L, etc.
- Press **CH ▼** or **CH ▲** to move between different ratings.
- Use **◀ VOL** or **VOL ►** to select ratings you want to block (RED) and unblock (GREEN).
- Press **MENU** to return to V-CHIP SET.
- Press **CH ▼** to select HOW LONG?.
- Press **◀ VOL** or **VOL ►** to select 12, 24, 48 hours or ALWAYS.
- Press **MENU** to return to Main Menu, then press **CH ▲** to exit.

U.S. TV Programs Ratings Chart Description

NR	Not Rated. SEE CUSTOMER CAUTION left.
TV-Y	All children. The themes and elements in this program are specifically designed for a very young audience, including children from ages 2-6.
TV-Y7	Directed to older children. Themes and elements in this program may include mild physical or comedic violence, or may frighten children under the age of 7.
TV-G	General audience. It contains little or no violence, no strong language, and little or no sexual dialogue or situations.
TV-PG	Parental guidance suggested. The program may contain infrequent coarse language, limited violence, some suggestive sexual dialogue and situations.
TV-14	Parents strongly cautioned. This program may contain sophisticated themes, sexual content, strong language and more intense violence.
TV-MA	Mature audiences only. This program may contain mature themes, profane language, graphic violence, and explicit sexual content.
FV	FANTASY/CARTOON VIOLENCE
V	VIOLENCE
S	SEX
L	OFFENSIVE LANGUAGE
D	DIALOGUE WITH SEXUAL CONTENT

Customer Caution

The V-Chip system that is used in this set is capable of blocking “NR” programs (non rated, not applicable and none) as per FCC Rules Section 15.120(e)(2). If the option of blocking “NR” programs is chosen “unexpected and possibly confusing results may occur, and you may not receive emergency bulletins or any of the following types of programming:”

- Emergency Bulletins (Such as EAS messages, weather warnings and others)
- Locally originated programming
- News
- Political
- Public Service Announcements
- Religious
- Sports
- Weather

U.S. Movies

This TV model features “V-Chip technology” which allows you to use Motion Picture Ratings when viewing movies or video tapes. This innovation allows parents to block various types of movies and video tapes at their discretion. Split will also be blocked automatically.

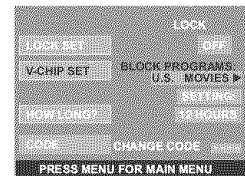

Note: Some movies are not rated for a variety of reasons. Old movies and foreign films are usually not rated.

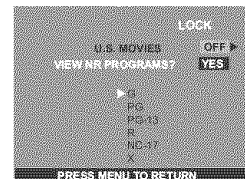

Procedure

- Press **CH ▼** or **CH ▲** to move between different ratings.
- Use **◀ VOL** or **VOL ►** to select ratings you want to block (RED) and unblock (GREEN).
- Press **MENU** to return to V-CHIP SET.
- Press **CH ▼** to select HOW LONG?.

ENGLISH

U.S. Movies (cont.)

- Press ◀ VOL or VOL ▶ to select 12, 24, 48 hours or ALWAYS.
- Press ^{MENU} ○ to return to Main Menu, then press CH ▲ to exit.

U.S. Movies Ratings Chart Description

NR	CONTAINS NO RATING (NOT RATED) AND NA (NOT APPLICABLE) PROGRAMS. Movie has not been rated or rating does not apply.
G	GENERAL AUDIENCES. All ages admitted.
PG	PARENTAL GUIDANCE SUGGESTED. Some material may not be suitable for children.
PG-13	PARENTS STRONGLY CAUTIONED. Some material may be inappropriate for children under 13.
R	RESTRICTED. Under 17 requires accompanying parent or adult guardian.
NC-17	NO ONE 17 AND UNDER ADMITTED.
X	ADULTS ONLY.

Canadian English

The V-CHIP used in this TV model allows you to block various types of movies and television programs based on the two ratings systems used in Canada. Split will also be blocked automatically.

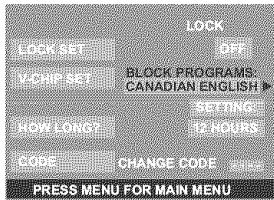

Note: E (Exempt) programming includes: news, sports, documentaries and other information programming, talk shows, music videos, and variety programming.

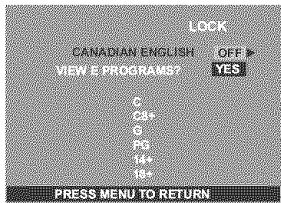

Procedure

- Press CH ▼ or CH ▲ to move between different ratings.
- Use ◀ VOL or VOL ▶ to select ratings you want to block (RED) and unblock (GREEN).
- Press ^{MENU} ○ to return to V-CHIP SET.
- Press CH ▼ to select HOW LONG?.
- Press ◀ VOL or VOL ▶ to select 12, 24, 48 hours or ALWAYS.
- Press ^{MENU} ○ to return to Main Menu, then press CH ▲ to exit.

Canadian English Ratings Description

E	Exempt - Exempt programming includes: news, sports, documentaries and other information programming, talk shows, music videos, and variety programming.
c	Programming intended for children under age 8. No offensive language, nudity or sexual content.
C8+	Programming generally considered acceptable for children 8 years and over. No profanity, nudity or sexual content.
G	General programming, suitable for all audiences.
PG	Parental Guidance suggested. Some material may not be suitable for children.
14+	Programming contains themes or content which may not be suitable for viewers under the age of 14. Parents are strongly cautioned to exercise discretion in permitting viewing by pre-teens and early teens.
18	ADULTS ONLY

Canadian French

The V-CHIP used in this TV model also lets you block or unblock Canadian French programs according to various ratings categories. Split will also be blocked automatically.

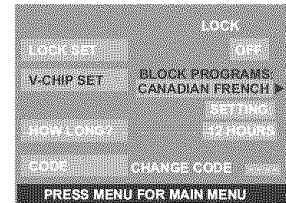

Note: E (Exempt) programming includes: news, sports, documentaries and other information programming, talk shows, music videos, and variety programming.

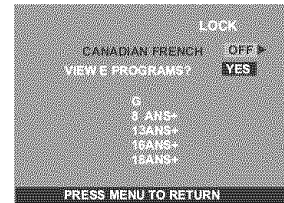

Procedure

- Press CH ▼ or CH ▲ to move between different ratings.
- Use ◀ VOL or VOL ▶ to select ratings you want to block (RED) and unblock (GREEN).
- Press ^{MENU} ○ to return to V-CHIP SET.
- Press CH ▼ to select HOW LONG?.
- Press ◀ VOL or VOL ▶ to select 12, 24, 48 hours or ALWAYS.
- Press ^{MENU} ○ to return to Main Menu, then press CH ▲ to exit.

ENGLISH

Canadian French (cont).

Canadian French Ratings Description

E	Exempt - Exempt programming.
G	General - Programming intended for audience of all ages. Contains no violence, or the violence content is minimal or is depicted appropriately.
8 ans +	8+ General - Not recommended for young children. Programming intended for a broad audience but contains light or occasional violence. Adult supervision recommended.
13 ans +	Programming may not be suitable for children under the age of 13 - Contains either a few violent scenes or one or more sufficiently violent scenes to affect them. Adult supervision strongly suggested.
16 ans +	Programming may not be suitable for children under the age of 16 - Contains frequent scenes of violence or intense violence.
18 ans +	Programming restricted to adults. Contains constant violence or scenes of extreme violence.

Main and Split Blocking Message

If V-Chip is enabled and the program exceeds the rating limit set by you, the blocking message will appear and the audio will be muted. Enter your four-digit secret code if you wish to continue viewing the program. After entering your code, all locks and rating blocks are disabled until the Projection Television is turned off or until all settings are reprogrammed.

Note: If you enter your four-digit secret code to override rating blocks, you must reset all rating blocks by either reprogramming or turning the Projection Television off.

Main Picture

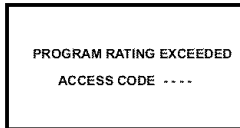

Split Frame

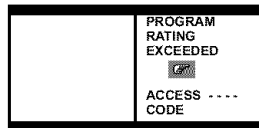

Note: To unlock split frame, press **SPLIT CTRL** button, will be displayed in split frame, then enter four-digit secret code.

SET UP



While the desired sub menu is highlighted, press **VOL** to select or activate feature.

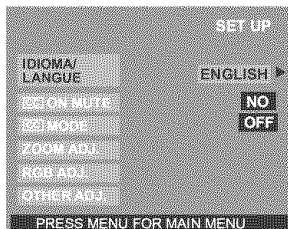

IDIOMA/LANGUE - Select to change menu language to ENGLISH, ESPAÑOL (Spanish) or FRANÇAIS (French).

CC ON MUTE - Activates the onscreen Closed Caption feature when the **MUTE** button on the remote control is pressed. To deactivate press **MUTE** button again.



CC MODE - This television contains a built-in decoder that displays **CC** (Closed Captioned) text across the screen (white or colored letters on black background). It allows the viewer to read the dialogue of a television program or other information. The program viewed must include Closed Captioning for the feature to work. Activate the onscreen Closed Captioning feature by selecting one of the following modes.

- OFF - When Closed Caption is not desired.
- C1 - For video related information to be displayed, up to 4 lines onscreen at a time. (It does not block relevant parts of the picture). Text may be in any language.
- C2 to C4 - For other modes of video related information.
- T1 to T4 - For program guide and other information to be displayed, when available. (Blocks a large portion of the picture on the television screen).

Note: C1 mode is recommended for viewing Closed Captions.

ZOOM ADJ. - This feature lets you adjust the size of the zoom picture and position it vertically.



Note: This feature is only selectable while in Zoom mode. Press the **ASPECT** button on the remote control for selecting Zoom mode.

RGB ADJ.

This feature is used to display RGB1 or RGB2 input signal correctly on screen.

Note: This feature is only selectable while in RGB mode.

- V-POSITION - To adjust the display vertical.
- H-POSITION - To adjust the display horizontally.
- CLOCK PHASE - To correct flickering or bleeding of the contour appearing on the screen when projecting a PC signal.
- DOT CLOCK - To make minor adjustments of the dot clock frequency. When a RGB signal is projected, the display area of the computer image can be adjusted.

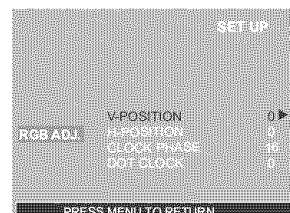

ICON MENUS OPERATION

□ OTHER ADJ.

Highlight OTHER ADJ. and press VOL ► to enter sub sub-menu field.

Note: While sub sub-menu features are highlighted, press VOL ► to adjust or activate.

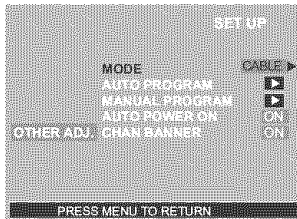

- MODE - To select TV (antenna) or CABLE mode depending on the signal source.
- AUTO PROGRAM - To automatically program all channels received through the RF input.
- MANUAL PROGRAM - To manually add or delete channels.
- AUTO POWER ON - Select SET to power up the TV at the same time as the Cable box or other components or select OFF.
- CHAN BANNER - Select ON to display onscreen banner when changing channels.

Photo Viewer Operation

Photo Viewer lets you display JPEG images recorded by a digital camera on an SD card or another type of memory card when it is inserted in the proper card slot.

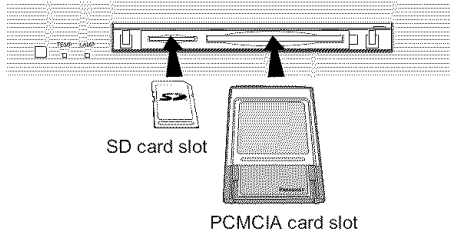

Notes:

- Photo Viewer can only show still images recorded by Digital Still Camera with DCF and EXIF standard JPEG file.
- Other types of Memory cards can be inserted into the PCMCIA card slot by using the appropriate card adapter.
- Memory cards are not supplied with this television.
- Some PC card adapter will not be compatible.
- Photo Viewer is not compatible with card type hard disks (Micro Drive, Mobile type hard disk, etc.)

Compatible card type and card size

SD card slot	
<input type="checkbox"/>	SD Card (1GB)
<input type="checkbox"/>	Multi Media Card (128MB)

PCMCIA card slot			
<input type="checkbox"/>	SD Card (1GB)	<input type="checkbox"/>	Flash ATA (128MB)
<input type="checkbox"/>	Multi Media Card (128MB)	<input type="checkbox"/>	Panasonic (1GB)
<input type="checkbox"/>	Smart Media (128MB)	<input type="checkbox"/>	SanDisk (1GB)
<input type="checkbox"/>	xD Picture Card (128MB)	<input type="checkbox"/>	GreenHouse (1GB)
<input type="checkbox"/>	Memory Stick Pro (1GB)	<input type="checkbox"/>	Hitachi (128MB)
<input type="checkbox"/>	miniSD Card* (128MB)	<input type="checkbox"/>	IO-Data (128MB)
<input type="checkbox"/>	Compact Flash (1GB)	<input type="checkbox"/>	Dynamic naked audio (128MB)
<input type="checkbox"/>	Memory Stick (128MB)	<input type="checkbox"/>	Kingston (128MB)

Note: These cards require standard PCMCIA adaptor.

Inserting and Removing SD or PCMCIA card

WARNING: As with any small object, SD cards can be swallowed by young children. Do not allow children to handle the SD card. Please remove the SD card immediately after use.

Procedure

- SD card - Push in the SD card into the SD card slot until it is clicked in. Press again on the card to remove it.
- PCMCIA card - Push in the card firmly until it is seated. To release the card, press the release button on the right side of the card slot. Before inserting or removing the PCMCIA card, make sure that the TV is turned Off. Otherwise, it may damage the TV or PCMCIA card. Do not insert anything other than the PCMCIA card.

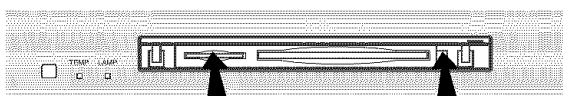

Push SD card in to release

Press the release button

Information regarding memory cards

- Memory cards must be formatted with FAT12 or FAT16 in order to be viewed on TV. If the card is not formatted, it may be incompatible with certain memory card adapters. If this happens, reformat the card using your digital camera. Refer to your camera manual for more information.

Note: Reformatting the card will erase the images stored in it.

Basic Operation

Insert either the SD card or the PCMCIA card into the appropriate slot. The video disappears from the screen while the Photo Viewer accesses the information from the card. After accessing images from the card, thumbnail images are displayed on-screen. Use the navigation keys to select the desired thumbnail and press **OK** button to display the image full screen. Use **◀VOL** or **VOL▶** to select the previous or next picture. Press **EXIT** button to exit Photo Viewer mode.

Photo Viewer - Thumbnail mode

The thumbnail screen is the initial entry screen. It shows the total number of images on the card, Filename (folder number and the number of the thumbnail that is highlighted), the date the picture was taken and the pixels (resolution) of the picture.

Procedure

- Insert SD or PCMCIA card to display the thumbnail screen.

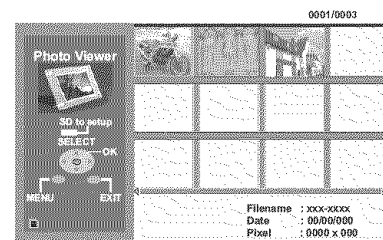

Note: It may take a long time to display the thumbnail screen if there are many files or if the files are large.

- Select the desired thumbnail image by using the Left/Right/Up/Down navigation keys.
- Press **OK** button to start the Single Picture View mode.
- Change the picture by pressing **◀VOL** or **VOL▶** keys.
- Rotate the picture if necessary, by using the **CH ▼** or **CH ▲** keys.

Notes:

- Maximum number of folders that can be displayed: **100**.
- Maximum file size: **3000**. Any folder of files larger than the specified size, will not be displayed.
- **Picture resolution:** Compatible in the range 64x64 - 8192 x 8192 (sub-sampling 4:2:2 or 4:2:0)
- If the image is imported from a PC, it must follow the EXIF (Exchangeable image file format) 2.0, 2.1, 2.2 in addition to the DCF (design rule for Camera File system) format, or it will not be displayed.
- If the JPEG is modified using a PC, it will not be displayed on TV.
- The Photo Viewer cannot display Motion JPEG and still image not DCF formatted (i.e. TIFF, BMP).
- If the file is partially corrupted, it may be shown in lower resolution.
- If both an SD card and a PCMCIA card are inserted at the same time, the SD card has priority. Otherwise, the card inserted second will have priority.
- Do not remove the SD card or PCMCIA card while Photo Viewer is accessing the information (when the card icon is flashing). Such action may damage the memory card or the Photo Viewer.

Photo Viewer Operations (Cont.)

Example of Folder Structure

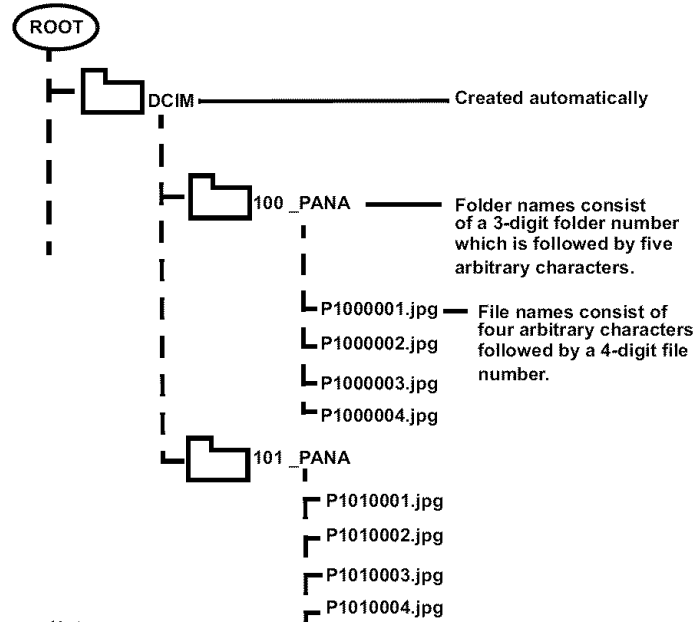

Note:
Folder and file names may vary according to the digital camera.

Photo Viewer Setup Menu

This menu allows you to customize features in the Photo Viewer Setup menu.

Procedure

- Insert the SD or PC card to display the thumbnail screen.
- Press the **SD** button on the remote control to display the Setup screen.
- Use the **CH**▲, **◀ VOL** or **VOL ▶** keys to navigate in the setup menu.

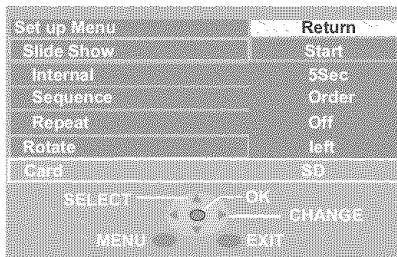

- Slide Show - Allows you to start the slide show by pressing the **OK** button while Start is highlighted. Press the **OK** button to stop the Slide Show.

Note: When in the Slide Show mode, you can change the aspect of the image on screen by pressing the **ASPECT** button on the remote control.

- Interval - Allows you to change the length of time that a slide is being displayed on screen. Available settings are: 5, 10, 15, 30, 60, 90 seconds and 10 minutes.
- Sequence - Select either Order or Random.
- Repeat - Select Off or On.

Note: After setting Interval, Sequence or Repeat, press **CH**▲ button to select Start, then press **OK** to start the Slide Show.

- Rotate - Allows you to rotate the image left or right.
- Zoom - Lets you select the magnification of the Single Slide display.

Procedure

- While in the Single Slide display mode, press **SD** button to display Photo Viewer Setup Menu. Zoom option will be displayed in the Setup Menu.
 - Highlight Zoom and press **OK** button.
 - Press **◀ VOL** or **VOL ▶** button to select To Fit, x2 or x4.
 - Press **OK** button. To move the image in the picture frame, press the navigation buttons.
 - Press **OK** to view the slide in normal magnification.
- Card - Select either SD or PC when both cards are inserted in the slots.

Following are some of the error messages that may be displayed on-screen when certain conditions are not met or exceed the Photo Viewer specifications.

Error messages



















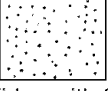

Error condition	Error messages displayed on-screen
When inserting card	No card or card is not inserted correctly
If the JPEG file is corrupted and cannot be decoded.	This type of image is not supported.
If the card is not formatted with FAT 12 or FAT 16 or if it is not DCF standard.	This type of format is not supported.
If thumbnail and main picture cannot be shown	 This icon will appear in place of the thumbnail image.
Over 3000 image files	Photo Viewer cannot support over 3000 JPEG files.
Resolution over	Photo Viewer cannot support over 8192 x 8192 pixels.
If incompatible card is inserted	This type of card is not supported.
The screen turned black to avoid image retention. Press any key to return to the normal display.	Press any key to return.

Photo Viewer Troubleshooting

Symptoms	Solutions
Cannot read the content of the card	A) Not compatible format. Must be formatted with FAT 12 or FAT 16. B) The extension is not "JPG". Photo Viewer can display EXIF standard JPEG file, and JPEG file which is not EXIF standard cannot be shown. C) The folders are not in compliance with DCF standard.
PC card cannot be ejected	Push the card all the way in, and eject.
Poor picture quality	If the main image cannot be read (the file is partially corrupted), the Photo Viewer will read the thumbnail. Please confirm the format of the image.
Long time to display	It will take a long time to display if there are many images or if the files are large.

Troubleshooting Chart





Before calling for service, determine the symptoms and follow suggested solutions.

AUDIO	VIDEO	Solutions
 Noisy Audio	 Snowy Video	Adjust antenna location and connection
 Noisy Audio	 Multiple Image / Color shift in picture	Adjust antenna location and connection Check antenna lead-in wire
 Noisy Audio	 Interference	Move television away from electrical appliances, lights, vehicles and medical equipment
 No Audio	 Normal Video	Increase Volume Check Mute Check television SPEAKERS on/off Change Channel
 Noisy Audio	 No Video with Snow	Set TV or Cable Mode Properly Check Antenna Cables
 No Audio	 No Video / No Split	Check if the Power Indicator is blinking orange Check if Power Cord is Plugged into Active Outlet Adjust Brightness and Audio Controls Change Channel Check Cable Connections Program the Remote Control Again Check Second Video Source Operation Make sure that a PC is not connected to HDMI (DIGITAL-IN) input.
 Normal Audio	 No Color	Confirm that cables are in the correct jacks Adjust Color Settings Change Channel Check for broken pins on S-Video cable
 Wrong Audio	 Normal Video	Check if Audio Is Set To Stereo or Mono, Not SAP
 Normal Audio	 Black Box on Screen	Change CC (Closed Captioning) from T1~T4 Mode
 Normal Audio	 Normal Video	Replace Remote Control Batteries
Intermittent Remote Control Operation		

TROUBLESHOOTING CHART (CONT.)

Troubleshooting Chart (cont.)

Before calling for service, determine the symptoms and follow suggested solutions.

SOUND	VIDEO	Solutions
 High whistling sound	 Normal Video	This is the sound of the internal DLP™ starting UP. This is not a malfunction.
 Normal Audio	 Some parts of the screen do not light up.	DLP™ is manufactured using an extremely high level of precision technology, however sometimes some parts of the screen may be missing picture elements. This is not a sign of a malfunction.
SYMPTOMS		CHECKS
Power will not turn on and Power LED is flashing	Please consult your nearest dealer.	
Power turns off and Temp LED is on	Let the set cool down, then turn back on. If Temp LED is still on, please consult your nearest dealer.	
Lamp LED is on	Replace Lamp or the lamp may be malfunctioning.	

ENGLISH

Index**Numerics**

3D Y/C Filter 22

A

AC Power Supply Cord 5

Affixing to a wall 5

AI Sound 22

Amplifier Connection 11

Analog RGB signals that can be Input 9

Antenna Connection 5

Aspect Button 13

Audio 22

Auto Power On 28

Auto Program 7, 28

B

Balance 22

Basic Menu Navigation 21

Bass 22

BBE 22

BBE Button 13

BBE VIVA 3D 22

Brightness 22

C

Cabinet and Remote Control 4

Cable / Antenna Connection 5

Cable Box Connection 10

Cable Connection 5

Canadian English 26

Canadian English Rating Description 26

Canadian French 26, 27

Canadian French Rating Description 27

Card 30

Care and Cleaning 4

CC Mode 27

CC On Mute 27

Chan Banner 28

Channel Scan 23

Channels 23

Cinema 22

Clock Set 24

Codes for Cable Box 17

Codes for Cassette Decks 18

Codes for CD Player 18

Codes for DBS 17

Codes for DVD 17

Codes for Personal Video Recorders 18

Codes for Receivers 18

Codes for VCR 17

Color 22

Color Matrix 22

Color Temp 22

Compatible formats 12

Compatible memory cards that can be viewed with Photo Viewer™ 29

Component Codes 16

Computer input 9

Connecting the Plug to the Wall Outlet 7

Customer Record 4

D

Digital TV - Set-Top Box (DTV-STB) or DVD Connection 11

Direct Video Input Selection 14

E

Error messages 30

Example of Folder Structure 30

F

Favorites 23

Feature Chart 4

Freeze Button 14

Front Panel 8

Front, Rear and Right side View of the Projection Television 8

H

HDMI (High Definition Multimedia Interface) input connection 12

HDMI In 23

I

Icon Menu Operation 22

Idioma/langue 7, 27

Important Information 1

Important Points to keep in mind 6

Information Regarding memory cards 29

Initial Set Up Menu 7

Input Label 23

Input Label Chart 23

Inserting and Removing SD or PCMCIA card 29

Installation 5

Interval 30

L

Lamp unit replacement period 6

Lock 24

Lock Set 24

M

Main and Split Blocking Message 27

Main Picture Freeze Feature 14

Manual Program 28

Mono 22

MPEG NR 22

N

Natural Color 22

Normal 22

O

Operating a CABLE BOX 19

Operating a cassette deck 20

Operating a DBS 19

Operating a DVD 19

Operating a PVR (Personal Video Recorder) 20

Operating a Receiver 20

Operating a VCR 19

Operating Components with Remote Control 19

Optional Cable Connections 5

Optional Equipment Connections 9

P

Photo Viewer Operation 29

Picture 22

Power Indicator Chart 7

Power ON/OFF 7

Preset Caption 23

Program Out Connection 11

Programming The Remote 16

Programming Without A Code 16

R

Rear Panel Jacks 8

Remote Control Battery Installation 5

Remote Control Operation 15

Repeat 30

Replacing the lamp unit 6

RGB ADJ. 27

RGB Input Connection 9

Right Side Panel 8

Rotate 30

S

Safety Precaution 5

SAP 22

SAP Button 13

Search Button 14

Sequence 30

Set Up 27

Sharpness 22

Sleep 24

Slide Show 30

Speakers 23

Special Features 13

Specifications 4

SPLIT CTRL Button 14

Split Operation 13

Split Operation With a Cable Box 13

Split Operational Buttons 14

Standard 22

Stereo 22

Surround 23

T

Table of Contents 3

Television Location 5

Thumbnail mode 29

Timer 22, 24

Timer 1 and Timer 2 24

Tint 22

Treble 22

Troubleshooting Chart 31, 32

TV/VIDEO Button 14

U

U.S. TV Programs 25

U.S. Movies 25

U.S. Movies Rating Chart Description 26

U.S. TV Programs Rating Chart Description 25

V

V-Chip Set 24

VCR and Cable Box Connection 10

VCR Connection 10

Video NR 22

Vivid 22

Z

Zoom 30

Zoom Adj. 27

**Panasonic Consumer Electronics Company,
Division of Matsushita
Electric Corporation of America**
One Panasonic Way
Secaucus, New Jersey 07094
www.panasonic.com

**Panasonic Sales Company,
Division of Matsushita Electric
of Puerto Rico Inc. ("PSC")**
Ave. 65 de Infantería, Km 9.5
San Gabriel Industrial Park Carolina,
Puerto Rico 00985
Tel. (787) 750-4300
Fax (787) 768-2910

Panasonic Canada Inc.
5770 Ambler Drive
Mississauga, Ontario
Canada L4W 2T3
Tel.: (905) 624-5010
Fax: (905) 624-9714
www.panasonic.ca

Panasonic de Mexico, S.A. de C.V.
Amores No. 1120
Col. Del Valle C.P. 03100
México, D.F.
Tel. (0155) 5488-1000
Fax (0155) 5575-6763, 5575-6765